



# HE-MAN AND THE MASTERS OF THE UNIVERSE

"REIGN OF THE MONSTER"

MU #6016

JANUARY 26, 1983

ACT ONE

STORYBOARD BY  
DON MANVEL

MU-16

LONG NOTE: ALL SC'S AT NIGHT  
EXCEPT SC'S 77-80

FADE  
IN  
90°  
TILT

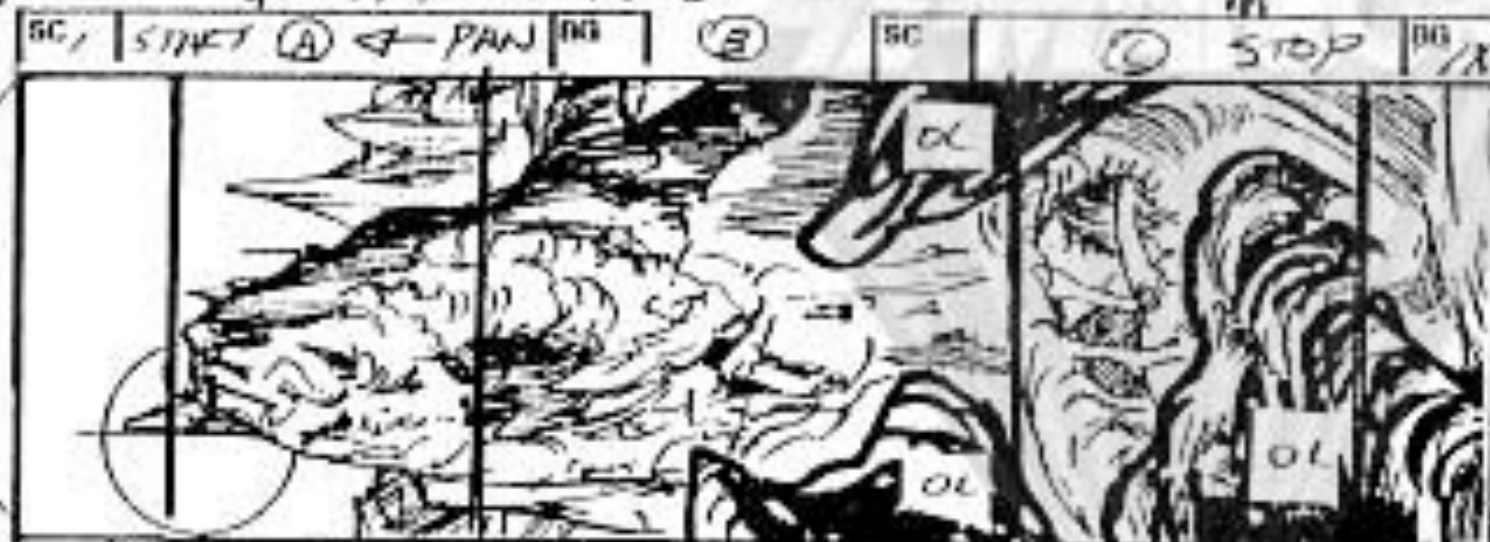

EXT- TORG MOUNTAIN - PAN DOWN TO CAVES WHICH LEAD TO UNDERGROUND -



TRK IN CAVE

TRK  
IN  
CD  
PANELS  
AT SEP  
SPEED

DIS

② DJS  
NOTE:  
CRYSTAL  
LAGE IS  
SEP.  
ELEMENT  
CD  
SOME  
TORG'S  
HOLD  
RAY  
WEAPONS  
CD

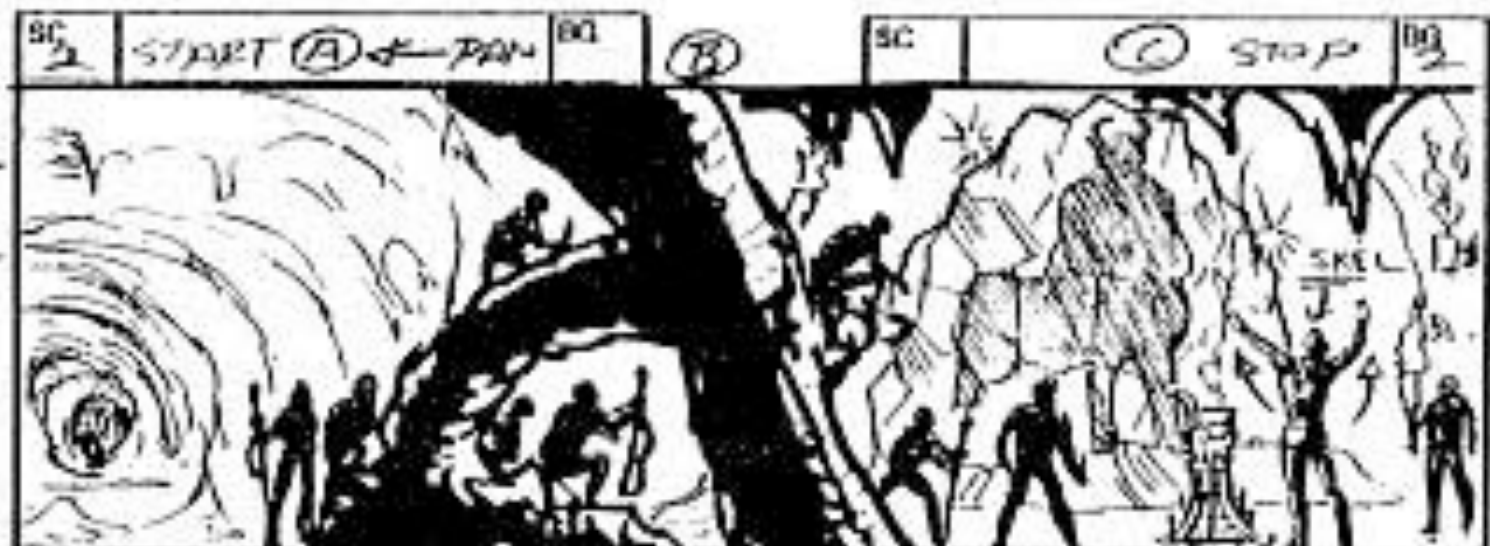

INT- TORG CAVES - MAIN CHAMBER. WE SEE TORG'S IN SHD AS THEY WATCH SKELETOR. HE GESTURES AT MOLKROM'S CRYSTAL LAGE. MOLKROM IS INSIDE THE CRYSTAL BUT HIS IMAGE IS BLURRED. SKELETOR (VO) powers of darkness, hear me!

MOLKROM  
IS FROZEN  
HOOK  
UP  
CD



CLOSER ON TRIPOD. LIQUID BOILS IN ITS BOWL

SKELETOR (con't) (W)  
Break open the Stone!

SC  
CONT  
CD

1

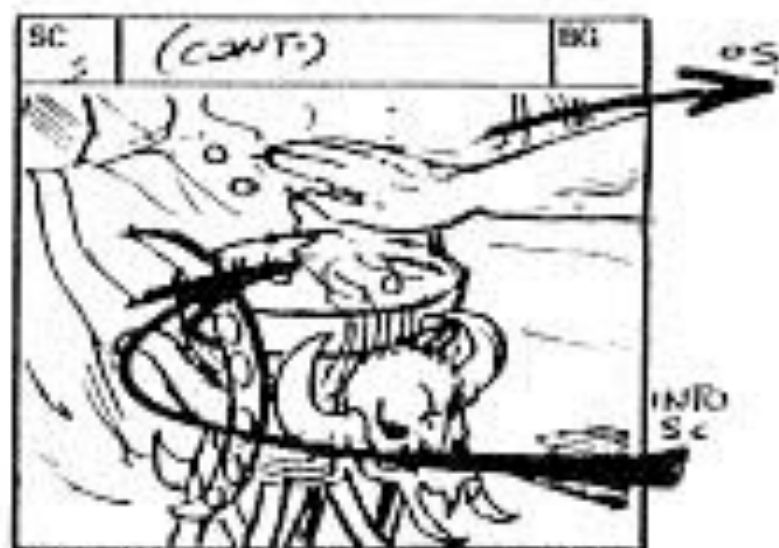

SKELETOR'S HAND PASSES THRU & OVER BOWL -



VAPORS ESCAPE -

HOLD UP  
2-4



VAPORS ENVELOPE MULKROM'S CRYSTAL AS TORGS AND SKEL LOOK ON -

2

M11-16

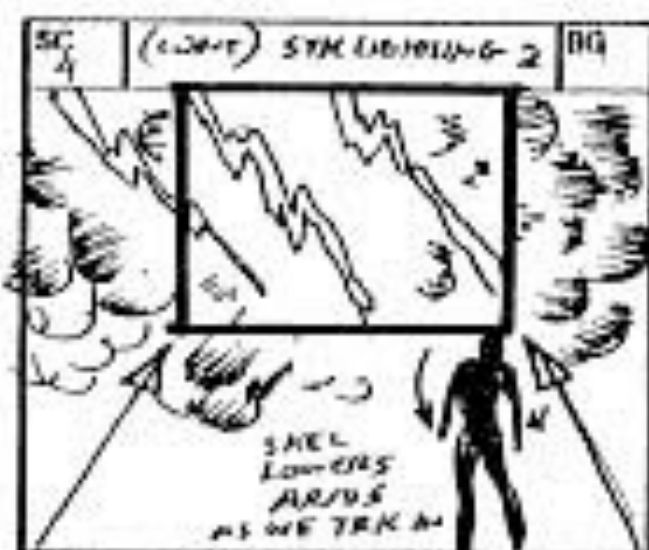

TRK IN CLOSER ON VAPORS AS LIGHTNING FY FLASH

SEX - THUNDER



THE VAPORS PART, BUT MULKROM REMAINS FROZEN

Nothing! SKELTOR (101)



TRK IN ON TRIPOD AS -

SKELTOR (cont'd) (10) None of my magic works!

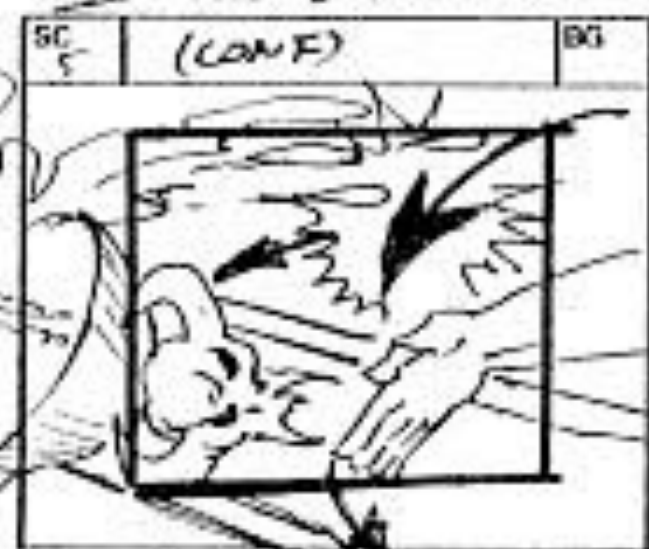

SKEL KNOCKS OVER THE BOWL IN ANGER

HOLD UP  
1-5 SC



LONG ON WUN AND TORGS SOLDIERS -

WUN  
Mulkrom, our prince of destruction has been imprisoned for centuries!

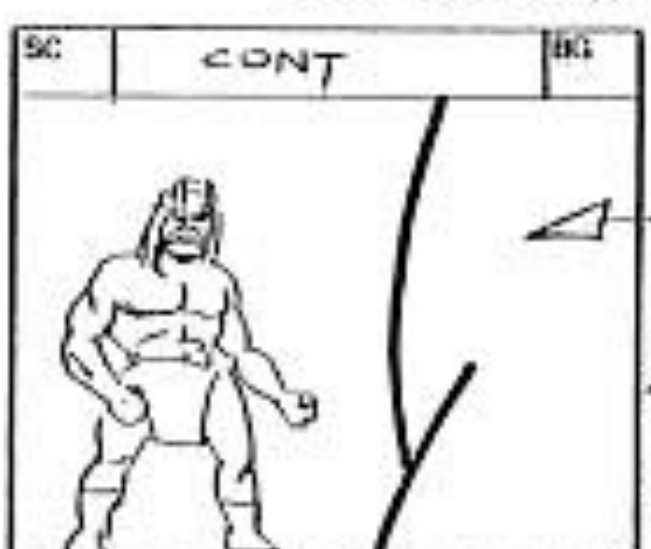

SKEL STOPS INTO SC.

HOLD UP  
2

2



HOOK UP W/ SC 6



CLOSER ON VON.  
VON (CON'E)  
You promised to find the weak point in the crystal and free him.

CRYSTAL



ON VON AND SKELE.  
SKELETON  
The magic of the Elders is too strong, King Von! Only something with their power will free him!

MAKE SKELETON STK  
SET UP SKEL TO W/W SC 131



VON  
I know of just such a thing, Skeleton!

ILLUSTRATION  
M-15

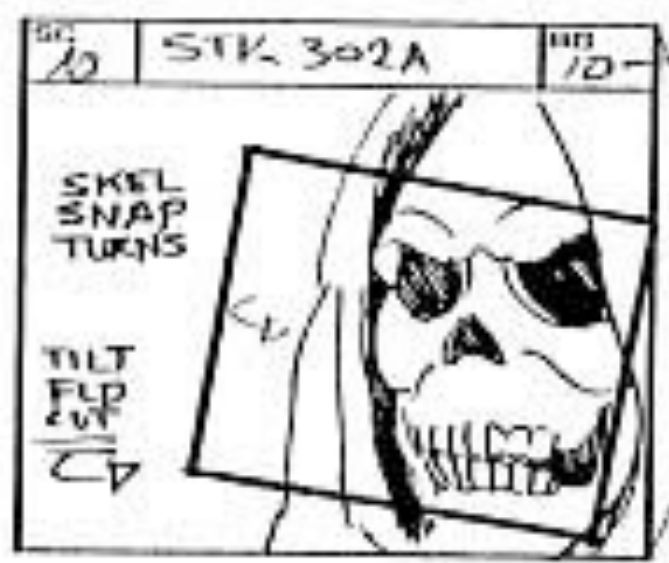

STK 302A  
SKELETON  
THIS ONE IS!

SKEL SNAP TURNS  
TILT FLIP UP

CAVE CARD  
DISE

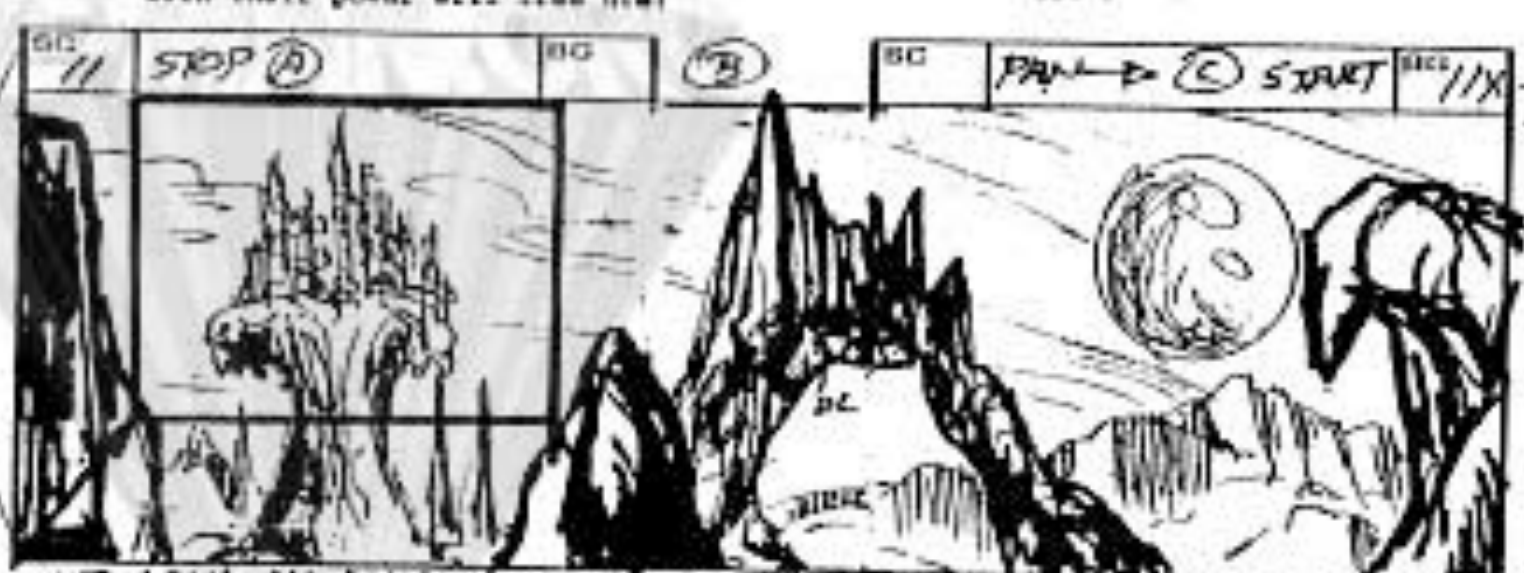

EXT-LONG ON AVION - A CITY OF TOWERS ON MOUNTAIN KINGDOM -  
TRK IN - STRATOS (CG)  
I'm glad you could make it to this celebration of ours, He-Man!

MOUNTAIN TERRAIN

V.I.P. NOTE:  
STRATOS HOLDS THE STAFF OF AVION

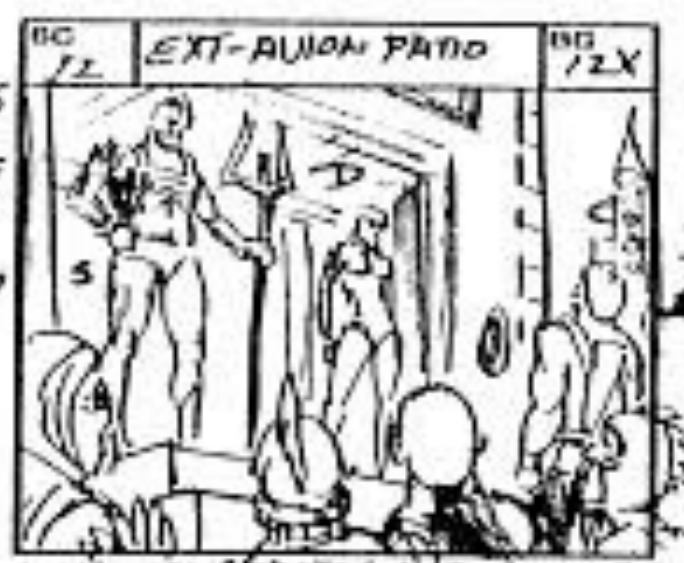

LONG ON STRATOS AND DELORA AS THEY ADDRESS CROWD.  
HE MAN  
I wouldn't miss it, Stratos!

HE MAN



ON OUR HEROES - AND CROWD IN SHD  
HE MAN (CON'E)  
It's only once a year you take out the Staff, given to your people by the Elders.

HOOK UP ORIG  
MAY BE AT HC

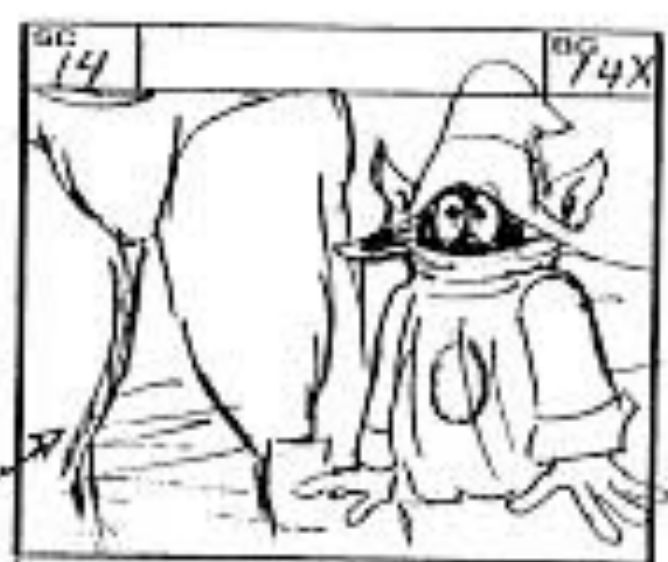

ORIO  
Just what does this staff do, Stratos?

3

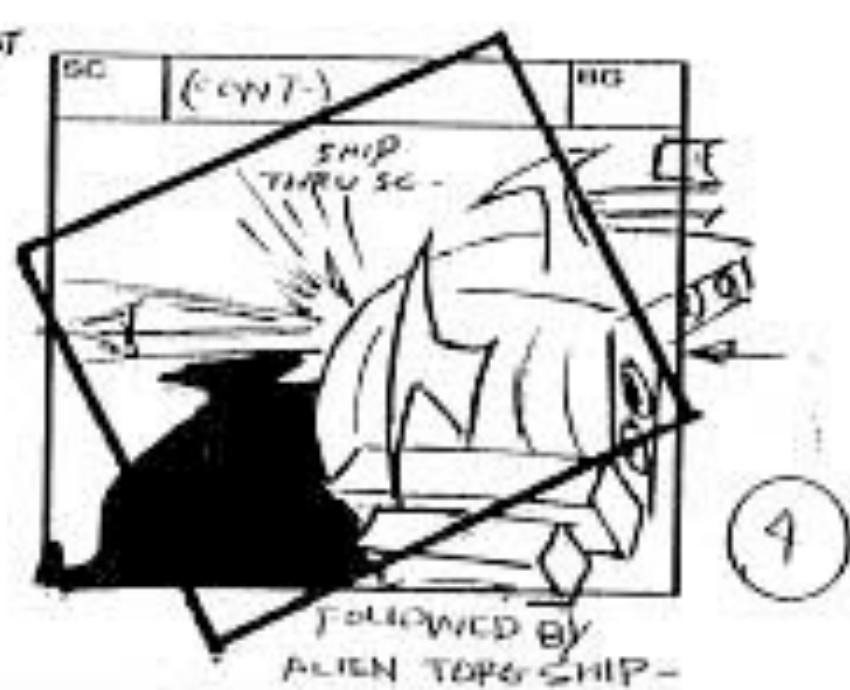
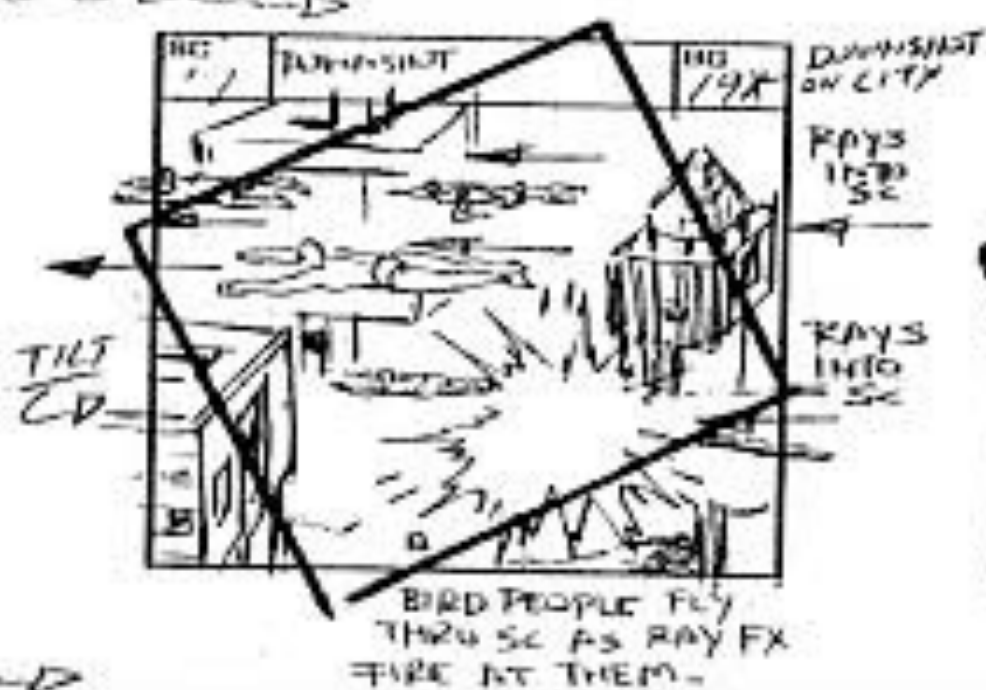
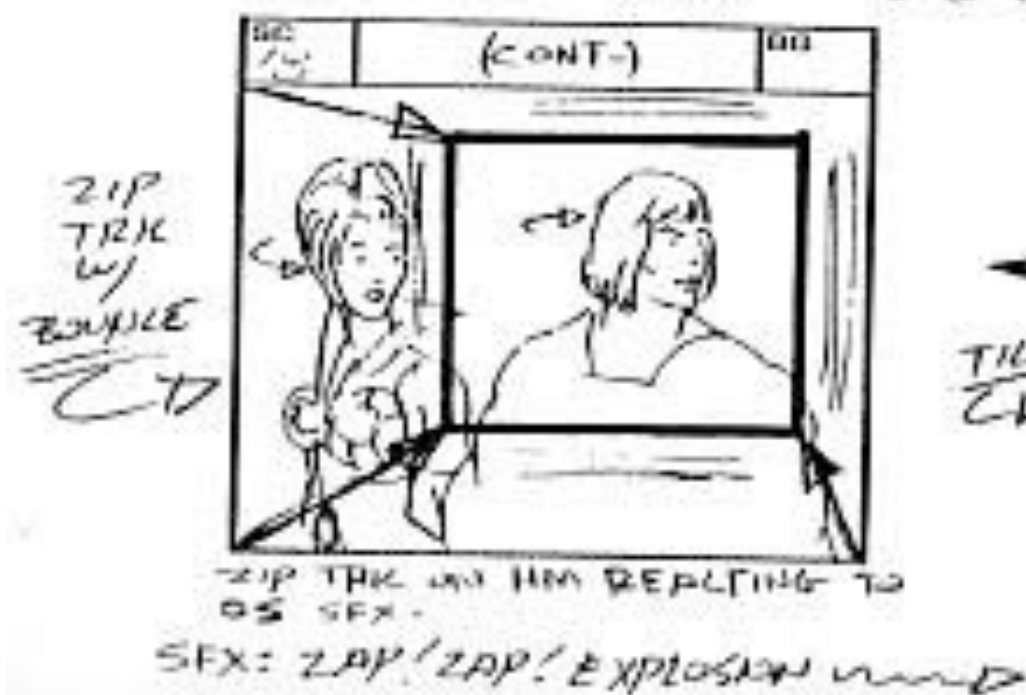
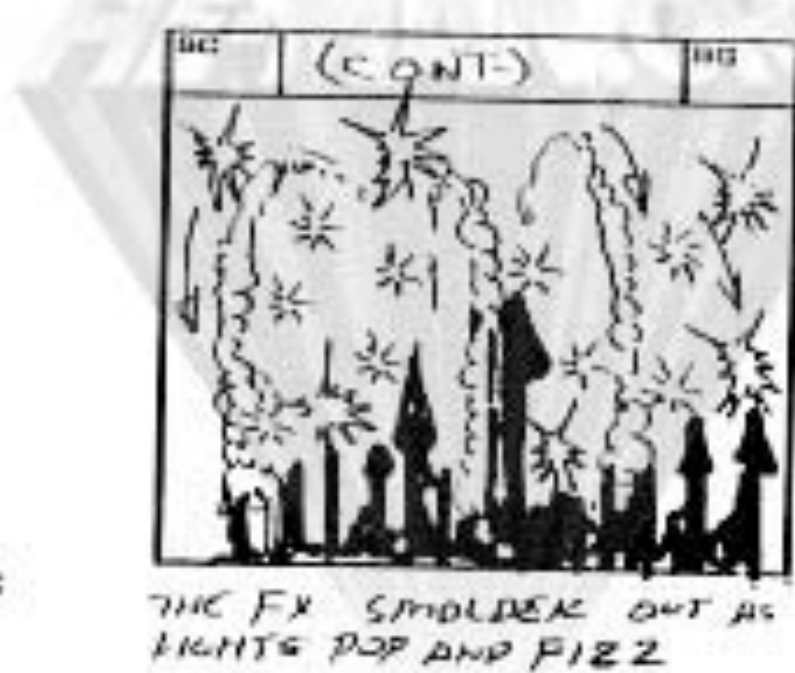
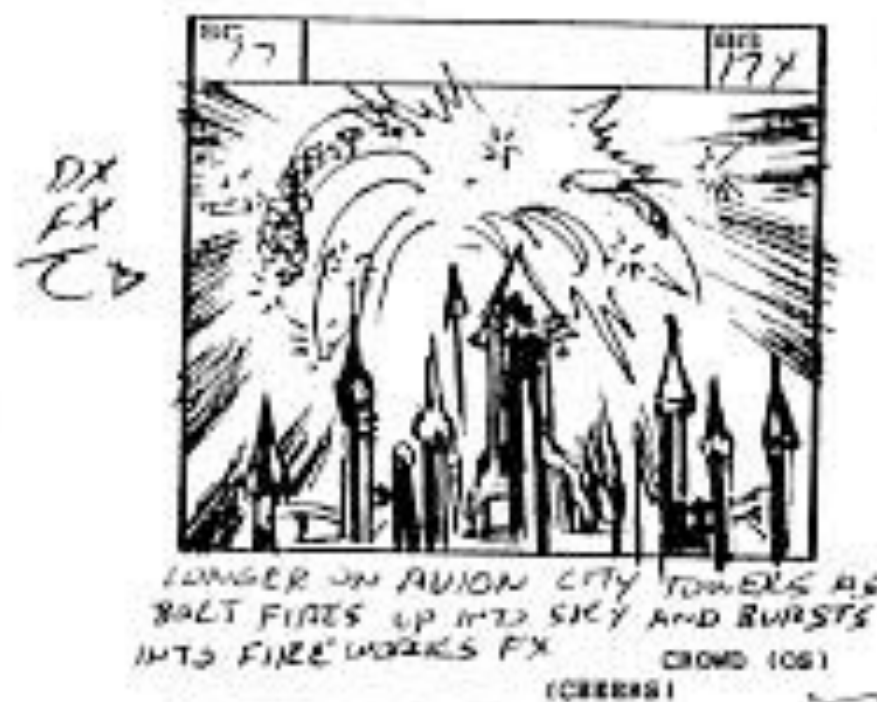
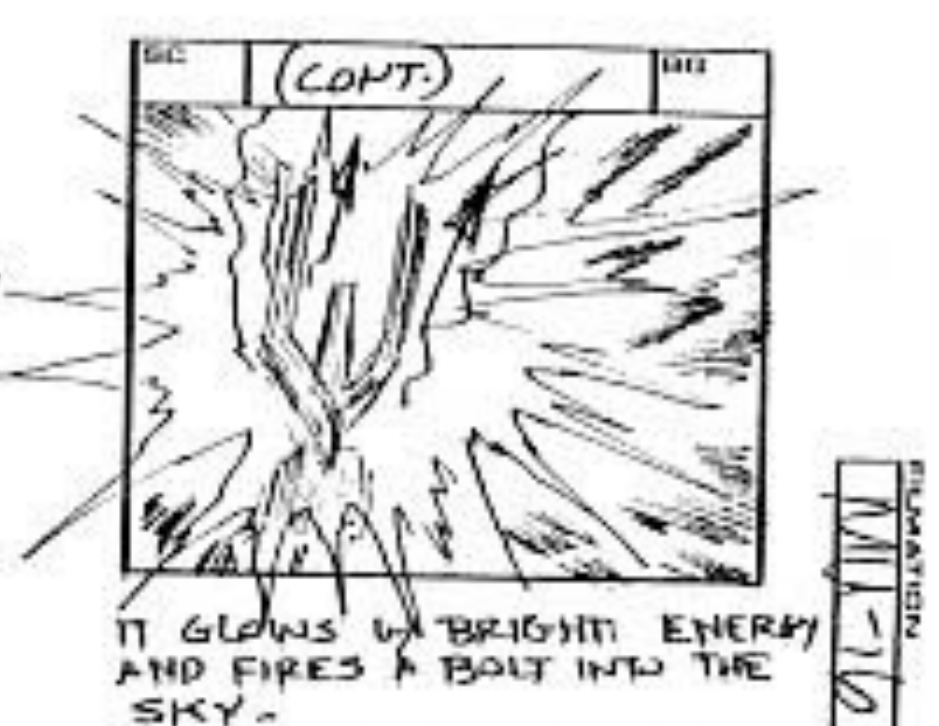
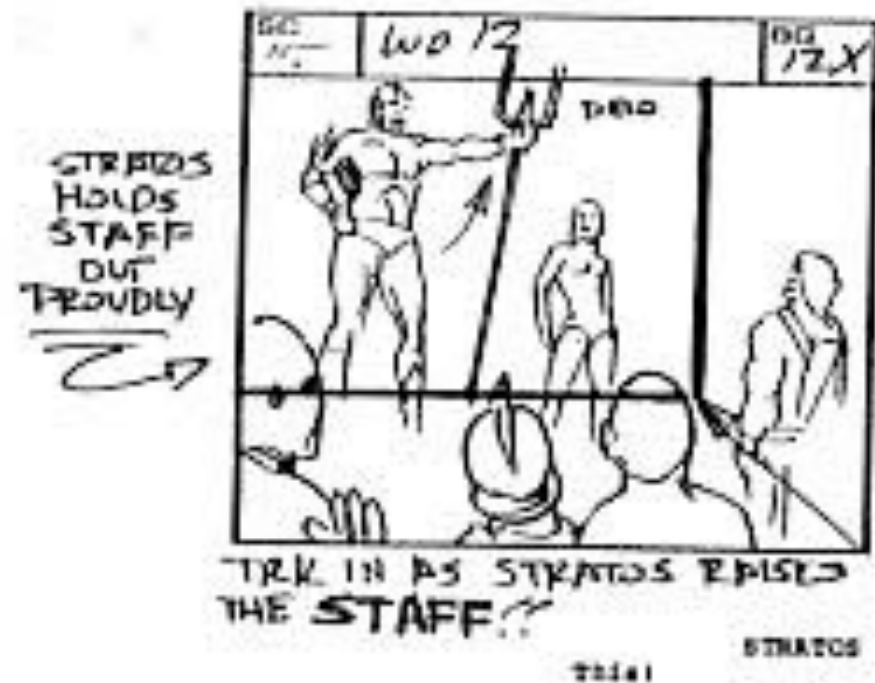



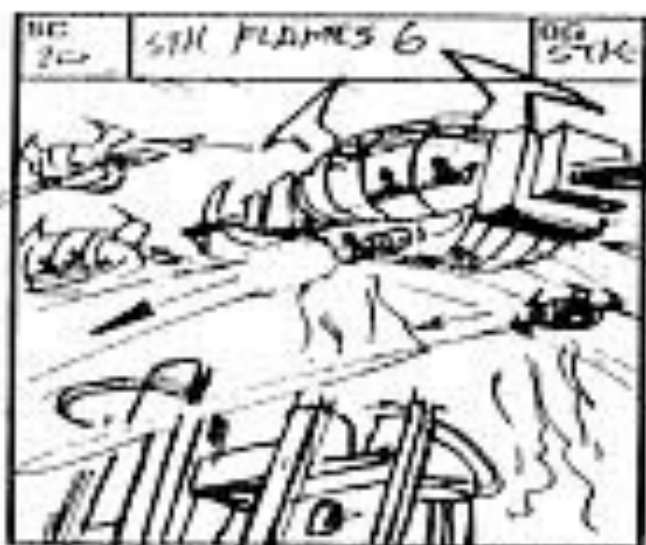

UPSHOT ON TORG'S SHIPS AS THEY HOVER INTO SC FIRING RAYS -  
DELORA (OS)  
Avion is being attacked!

STK 2X (HOLD)  
UL 2DX

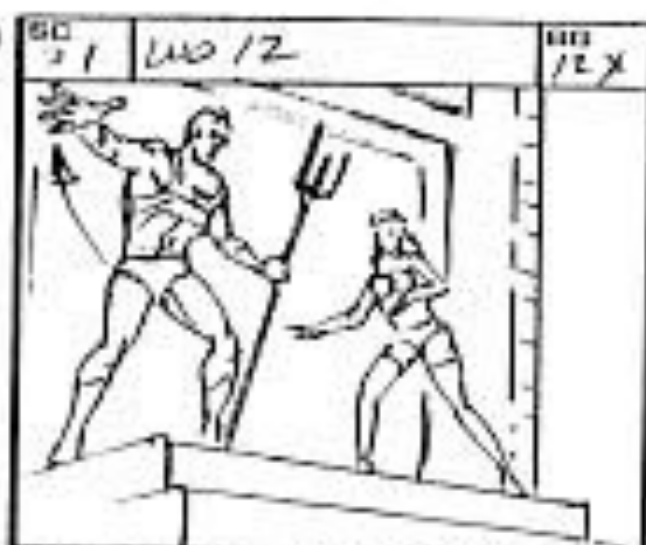

ON STRATOS AND DELORA REACTING

STRATOS  
Man the defenses!

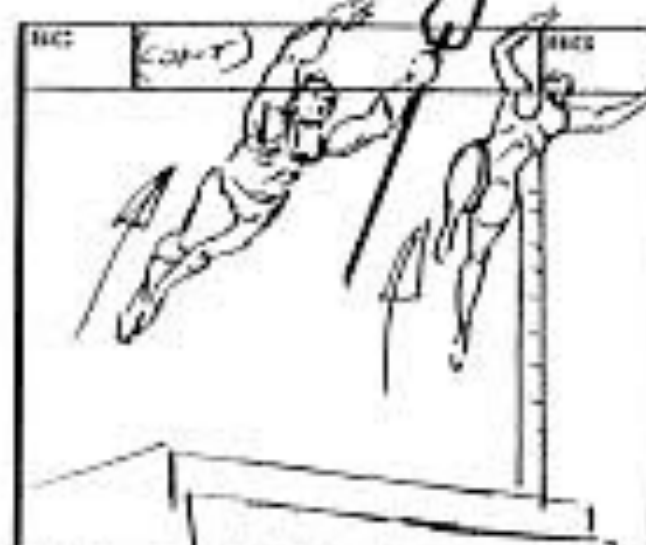

THEY FLY UP AND OS AS --

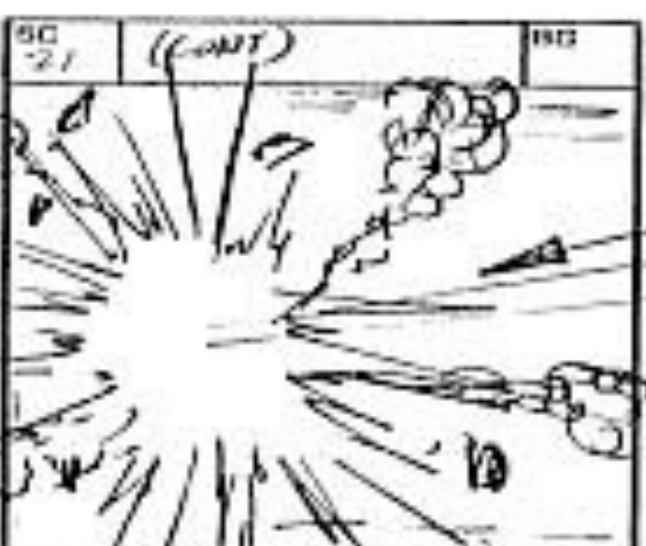

RAY FIRES INTO SC

STK EX!  
CAM SHAKE

TRK IN

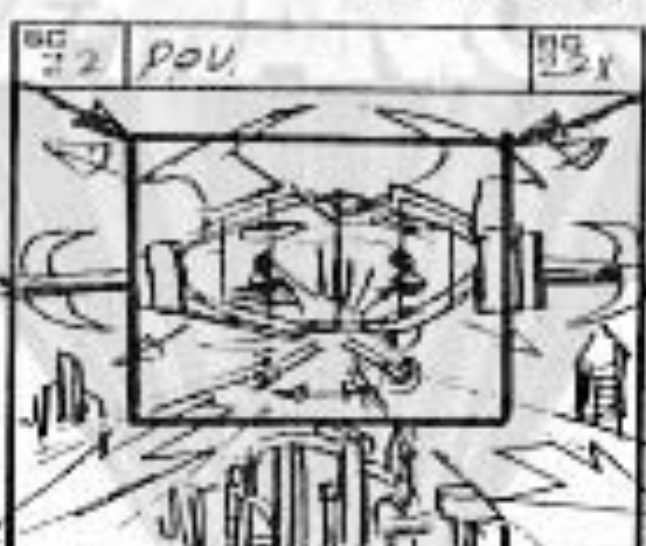

TORG SHIP XEROXS TO CAM AS IT FIRES RAY ENERGY -



ORKO TAKES

DIAL USED OUT OF SEQ. SCRIPT  
SC 38 & 39

Yikes! ORKO

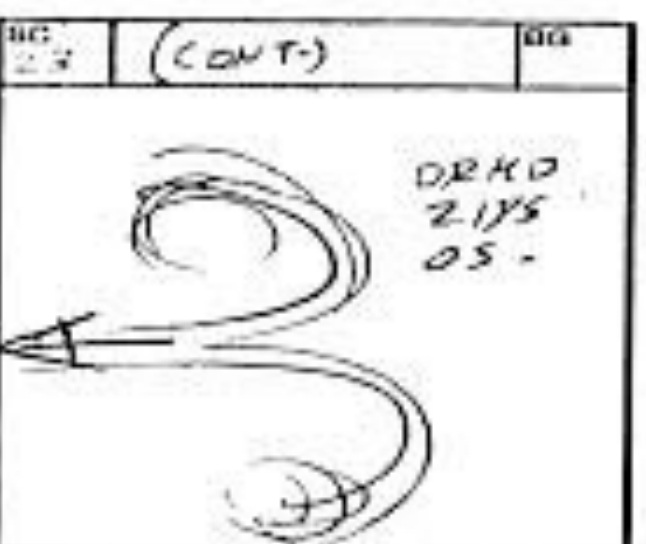

DRKO  
ZIPS  
OS -

START SC W/ CAMALISE IN CENTER SHOT



HIM RUNS OS (P) AS BC, RAINMAN, TEELAND MAN AT DWMS RUN 24



HIM MAN RUNS AND LEAPS PAST CAM JUST AS --

STK EXPLOSION  
XIS  
4  
SC CONT  
5

ILLUSTRATION  
21-16

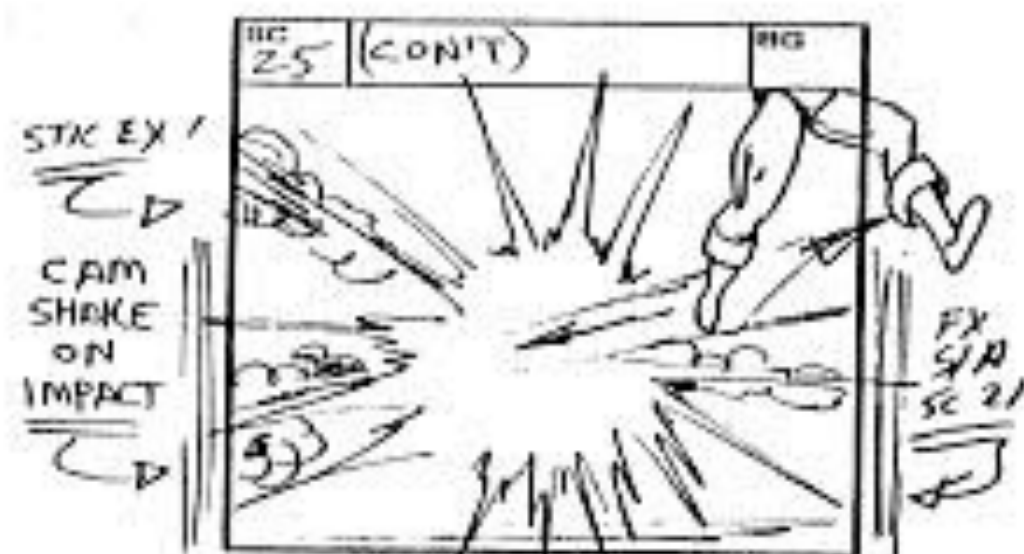

RAY BLAST INTO SC, JUST MISSING HIM.

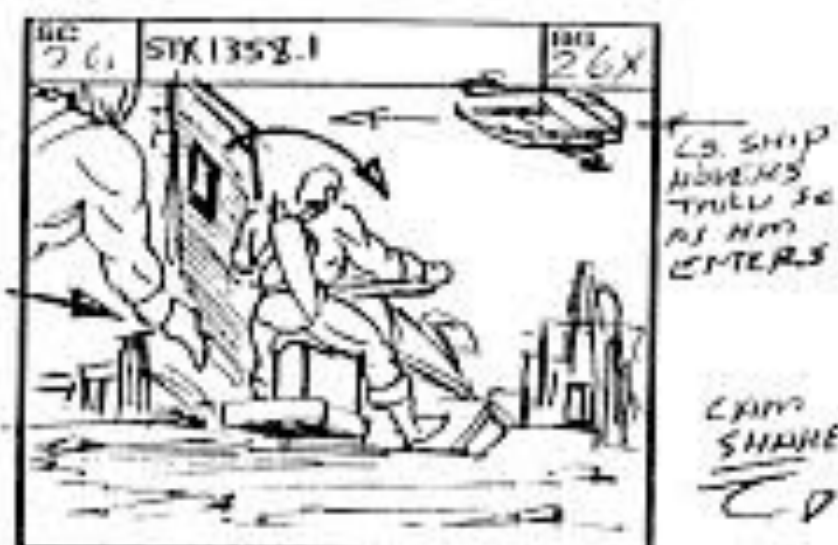

HIM INTO SC - HOPS INTO SKY SLED.

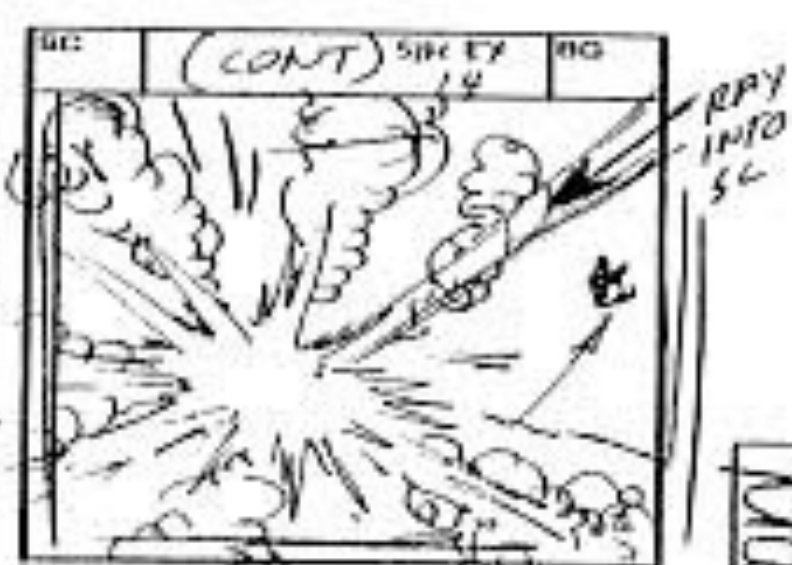

AS ANOTHER RAY BLA

ILLUSTRATION  
01-10



ON PHOTON CANNON EMPLACEMENTS AS TELLA AND MAA RUN THRU SC TO AVOID RAY BLAST - HXO A BENT.

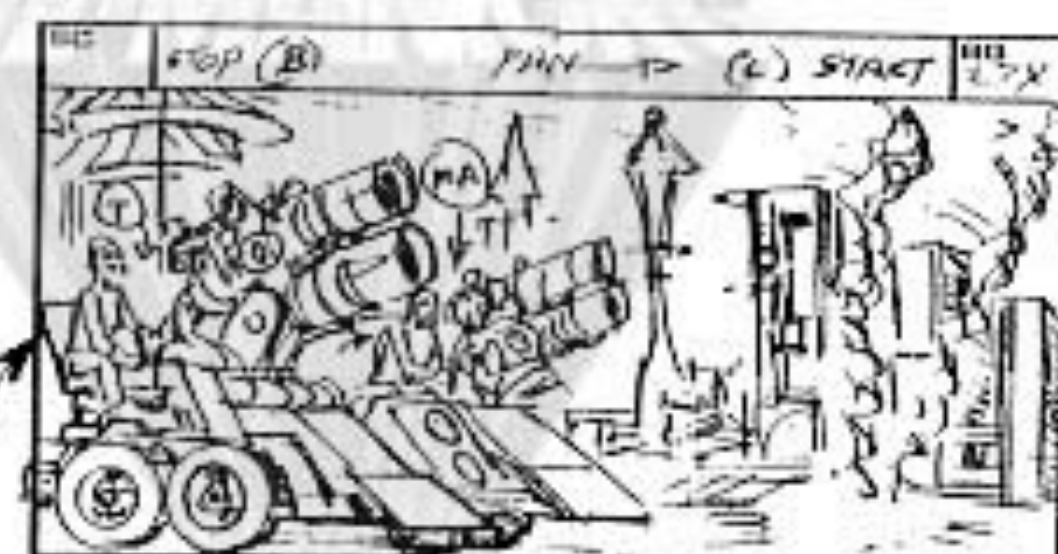

PAH OVER TO THEM GETTING INTO CANNON CONTROL COXIPITS.

SEE SCENE 43 FOR (A) POS

HOOK MAA W/ SC 28

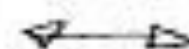

CLOSER: MAA AT CONTROLS - MAA AT ARMS  
Know how to work a photon-cannon, Teela?



TEELA AT CONTROLS - LOOKS AT MAA AT OTHER CONTROLS  
I'm a fast learner, Teela!



TEELA LOOKS DOWN - TRK IN AS SHE FIRES PHOTON GUN

6



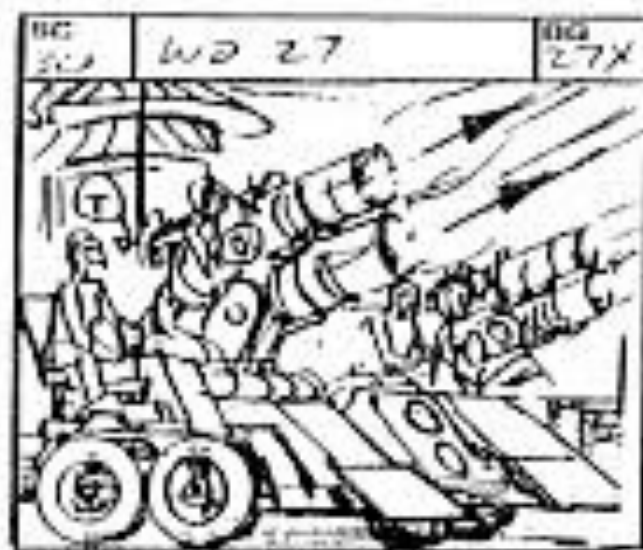

TEELA AND MAA FIRE PROTON CANNONS.

ULOL 27X

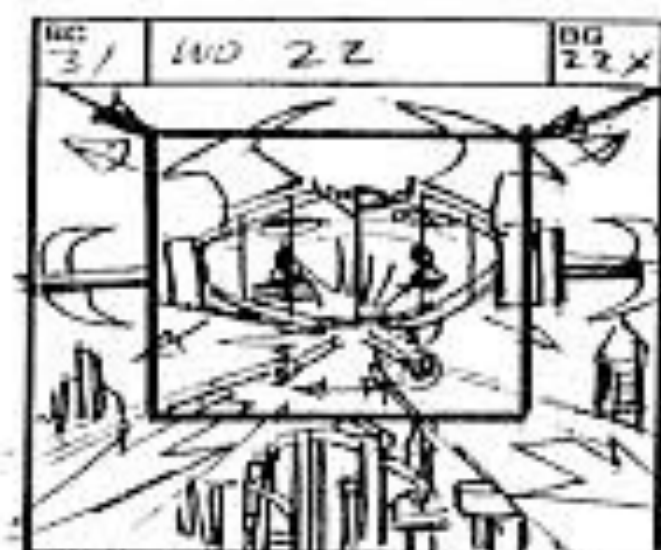

TRIC IN AN SHIP FIRING RAYS.

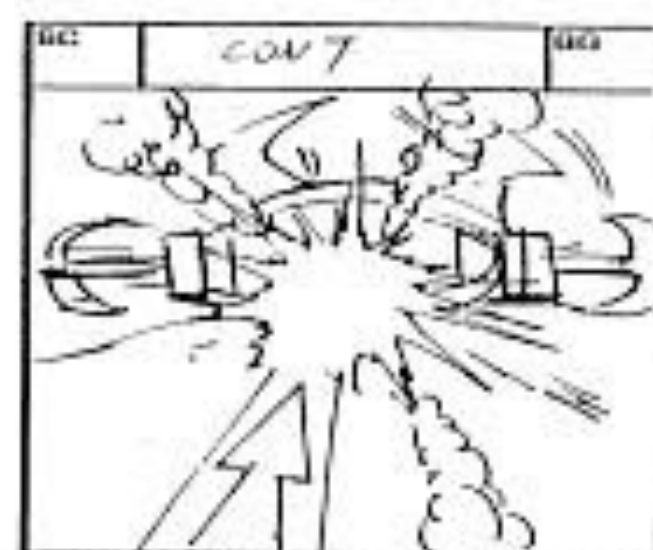

PROTON RAY HITS THE SHIP, STAGGERS IT A BIT.

FILMATION  
MU-16

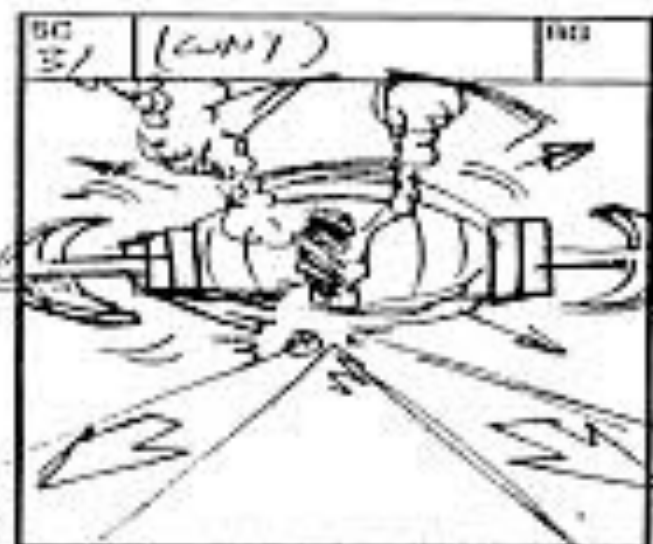

THE SLIGHTLY DAMAGED SHIP SLOWLY CONTINUES TOWARD LAND, FIRING RAYS.



HE MON THRU SC AS RAYS FIRE THRU, MISSING HIM.



EXTREME UPSHOT - HE MAN ON SILEY SLED GAINS ON PAN AS FIRES CANNON AS HE HOLDS POS.

6X  
4 TAN  
MAKE SLED AND NET STK

DROPPAL SCRIPTS  
TONGS  
BATHROOM  
(MAY BE GONG)



HOLD TIGHT AS HIS RAY STRIKES A SHIP.



TRIC OUT FULL FAST AS SHIP PLUNGES DOWN WHILE HE MAN SWOOPS THRU SC

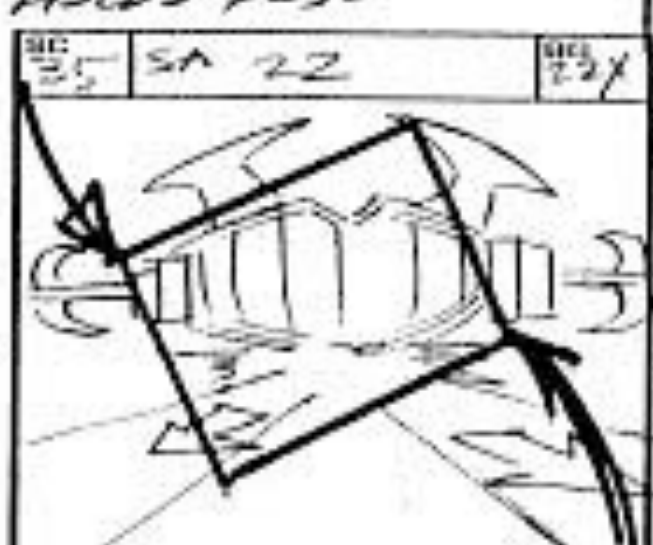

TRIC IN AN SHIP AS IT FIRES RAYS.

7

DROPPAL  
SCRIPT SC 30

SEE HOW  
LET'S SEE IF WE CAN GET THOSE  
MACHINES DOWN TO SIZE!

5TH FLAME UL 20X

TILT TRIC  
IF  
CD

RAY  
FX S/A  
SC 32  
CD  
STARTS  
INTO  
SC

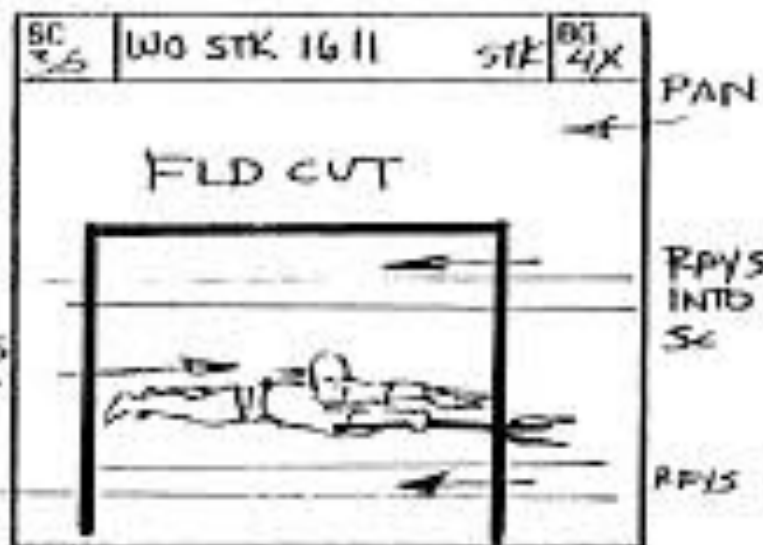

STARTS EARLY ON PAN - HE  
HOLDS THE STAFF OF AVION -



CLOSER ON STRATOS - HOLDING STAFF  
STRATOS  
Got to stop those heat-rays!

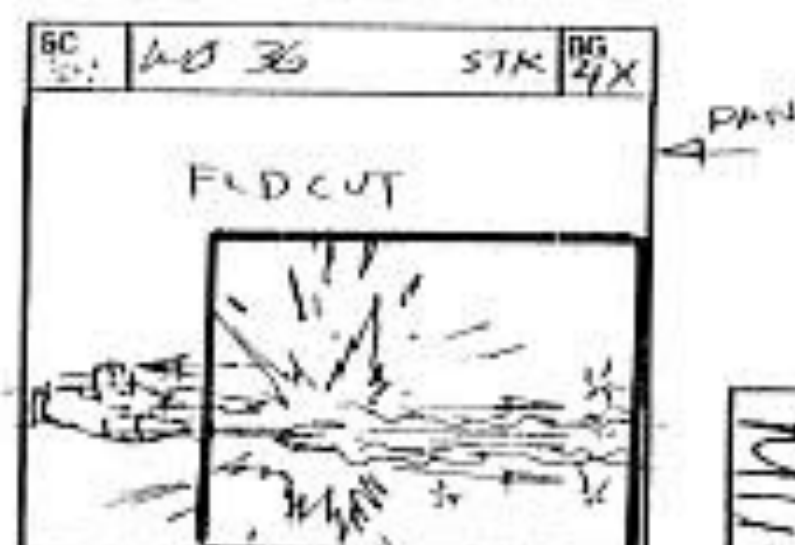

STRATO LOSES ON PAN AS  
STAFF FIRES ENERGY  
BOLT OF -

M1-16

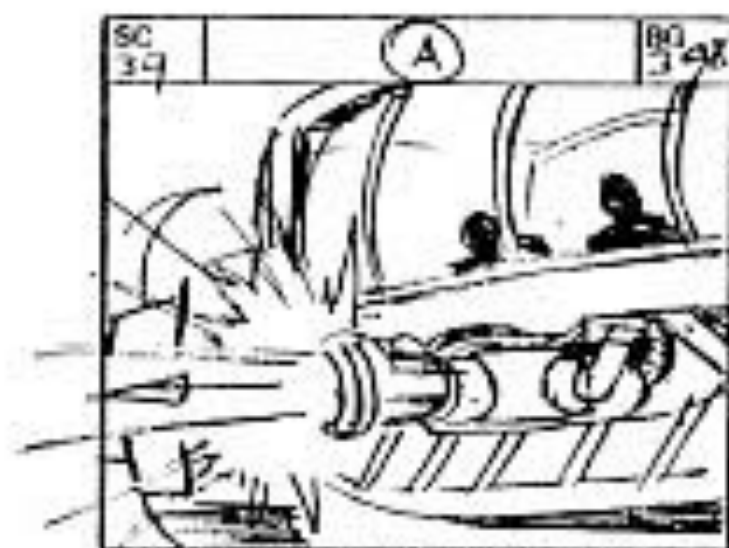

CLOSE ON FRONT OF TDR'S  
SHIP AS IT FIRES RAY -

NOTE  
SET UP  
- TO  
W/W  
SC 58



THE STAFF'S BOLT STRIKES  
CANNON -

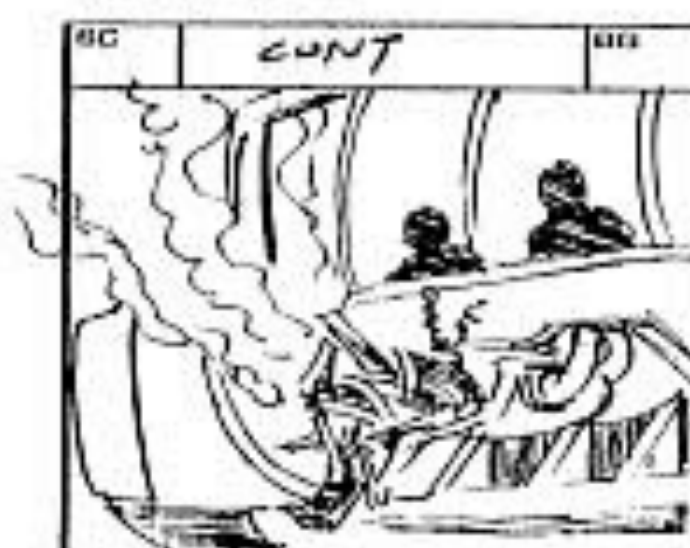

HOLD A BEAT ON DAMAGED  
CANNON.

TILT  
FLD  
CD

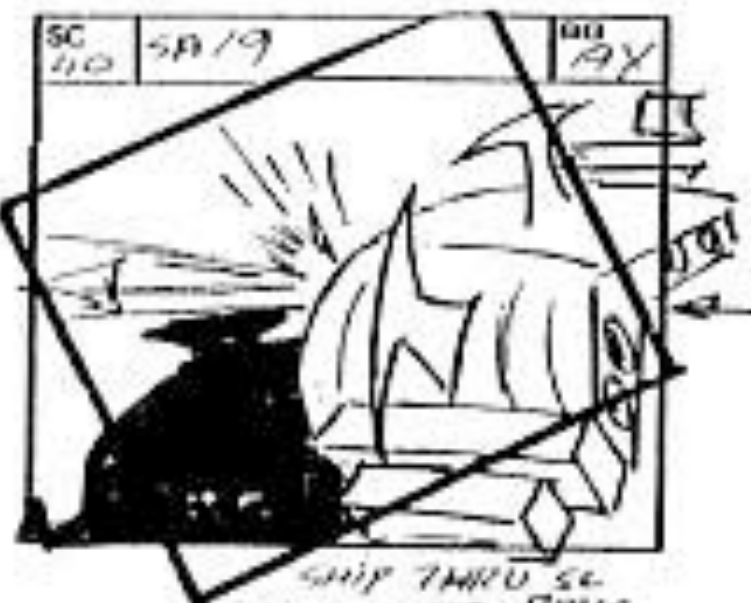

SHIP THRU SC  
AS IT FIRES RAYS

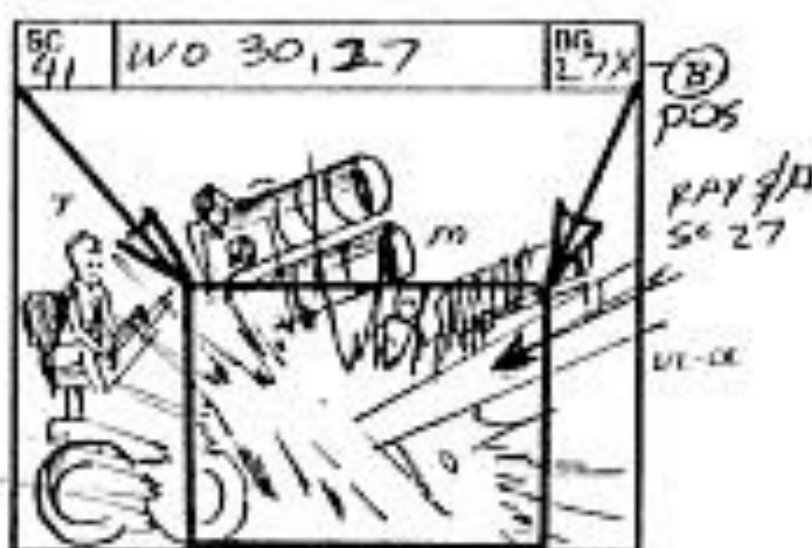

TRK IN AS RAY STRIKES  
THE 127X CANNON

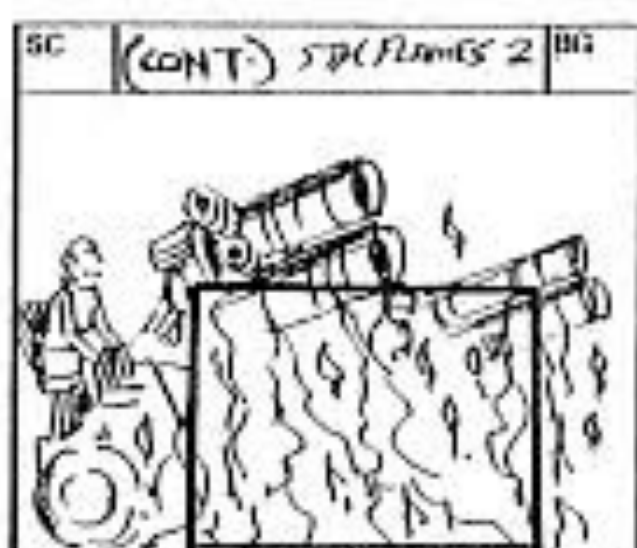

FLAMES ERUPT IN FOREGROUND



FLD  
STIK  
FLAMES



MMA REPTS TO FLAMES IN BG  
HAR AT ARMS  
CLOSE OUT!

DL 28X

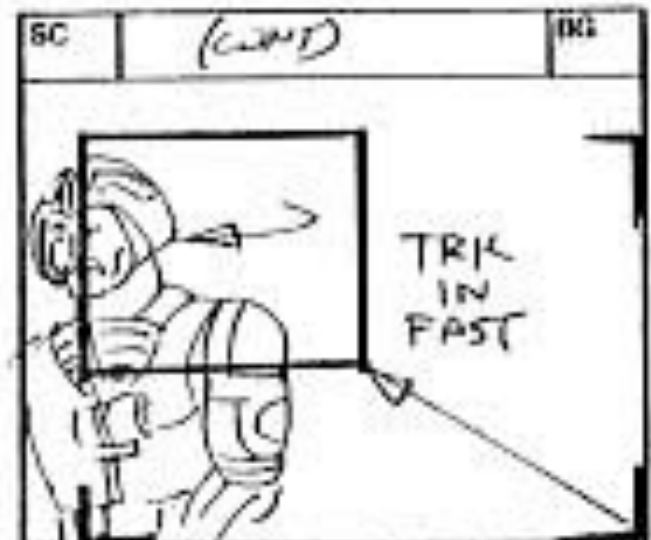

HE EXISTS OS FAST



TEELA & MMA RUN OS FROM FLAMING EDNION PS

10 PCS

DL 27X  
STIK FLAME

91-116

ZIP  
TRK  
IN W/  
BOUNCE

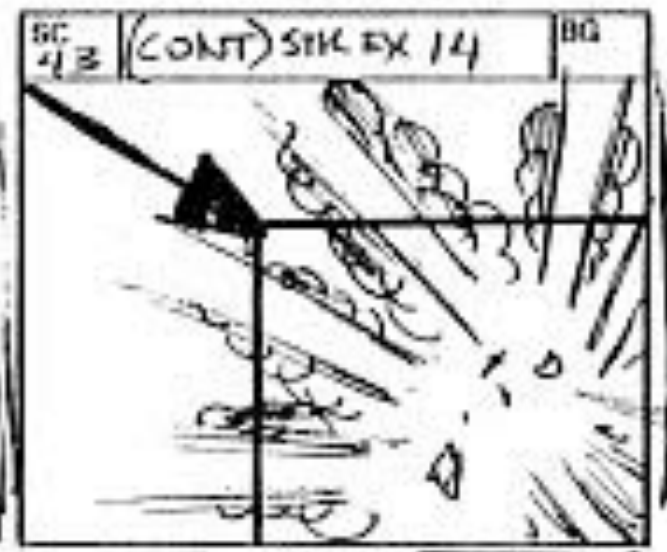

SHIPS INTO SC - FIRE RAYS

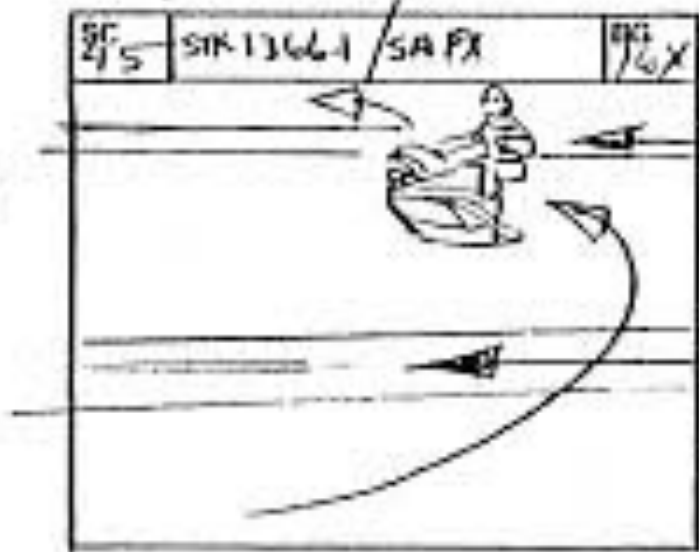

HM SWOOPS UP THRU SC PS  
RAYS MISS HIM

RAYS INTO SC

RAYS INTO SC

FX S/A SC 32

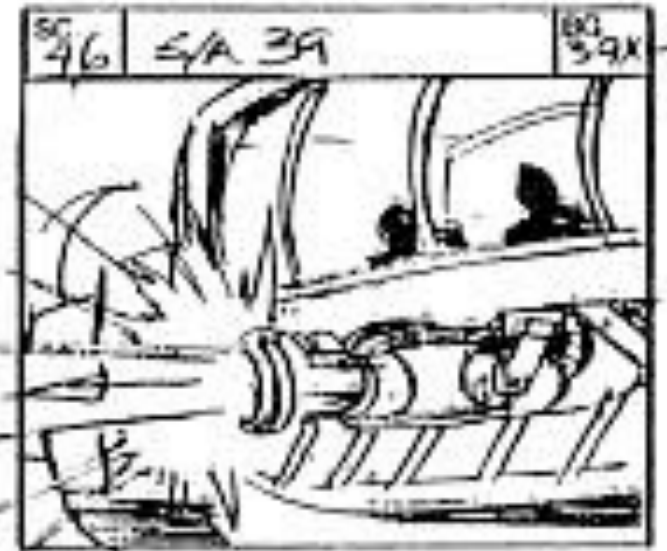

SHIP FIRES AWAY -

11 PCS

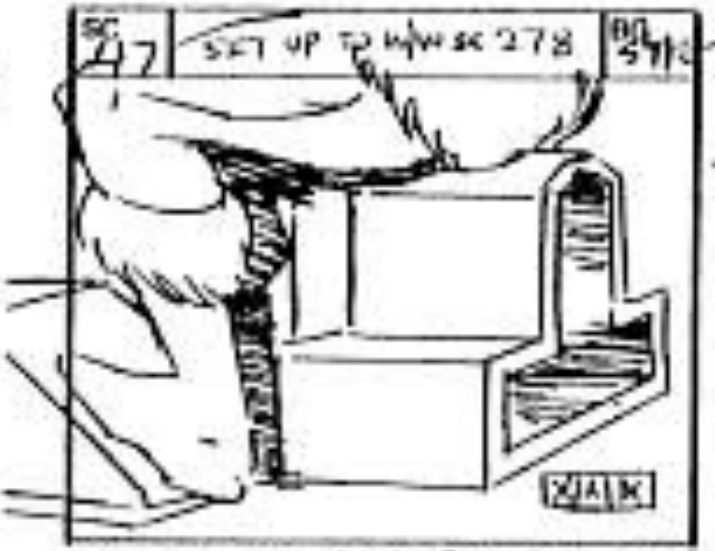

CLOSER ON HM ON SKY SLED PS --

5X  
PAN  
SKY

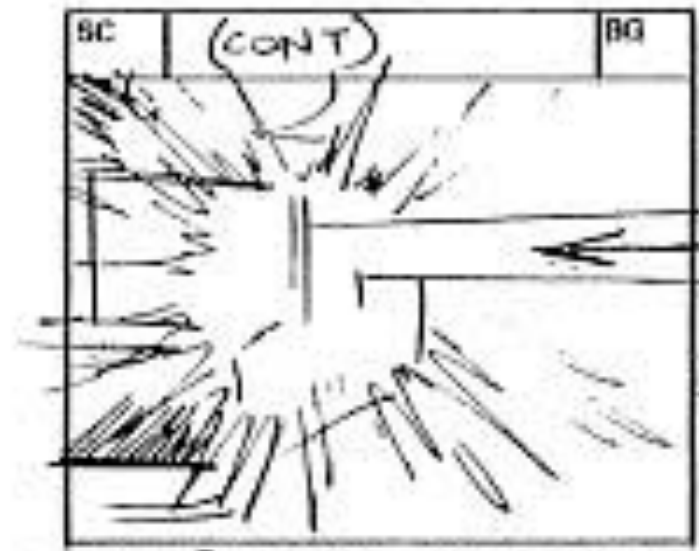

RAY ENTERS SHOT AND STRIKES REAR OF SKY SLED

PAN

SC CONT

9

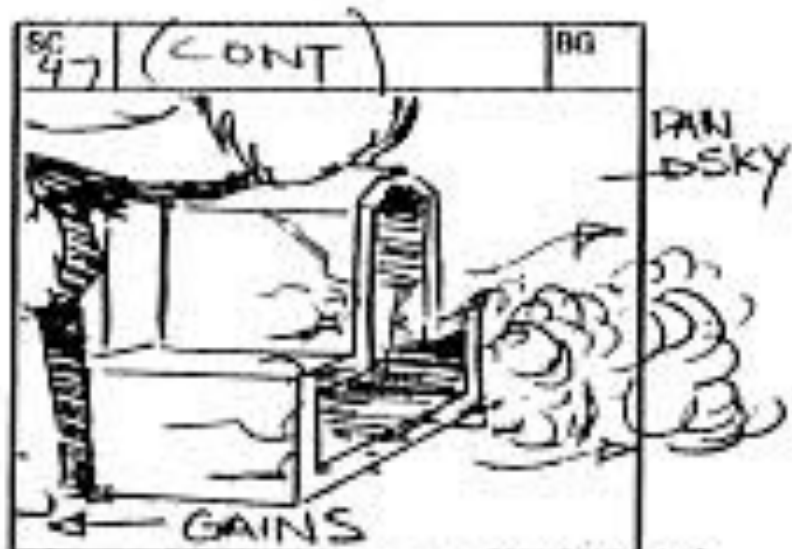

THE DUMPED SLED GAINS ON PAN AS SMOKE ESCAPES -

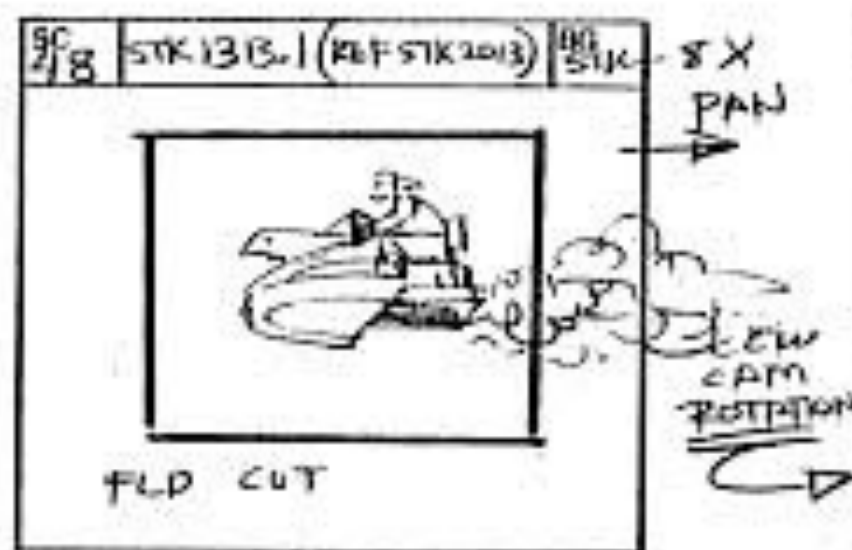

ON HM ON SMOKY SKY SLED AS IT SWOOPS DOWN ON -

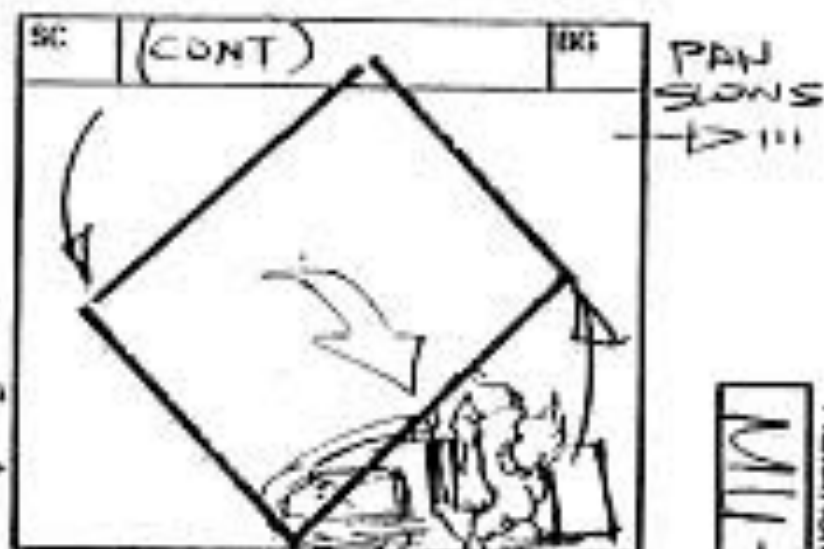

M11-16

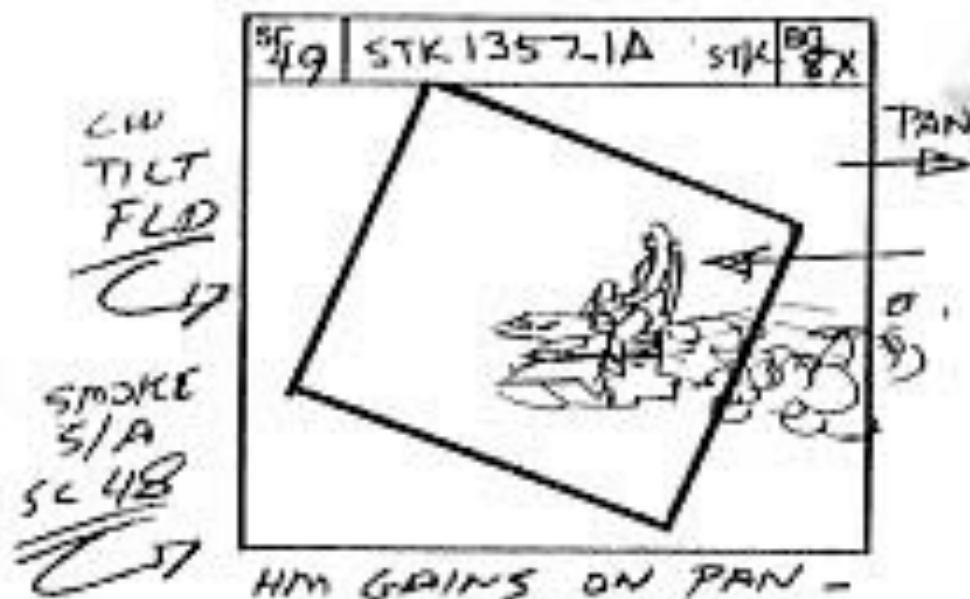

HM GAINS ON PAN -



HM STRUGGLES W/ CONTROLS  
EE HAS  
(restraining)  
got to keep the coe up!



HE HM SWOOPS INTO DISTANCE  
BEYOND BUILDINGS -



PAN FAST TO OTHER BUILDINGS AS -

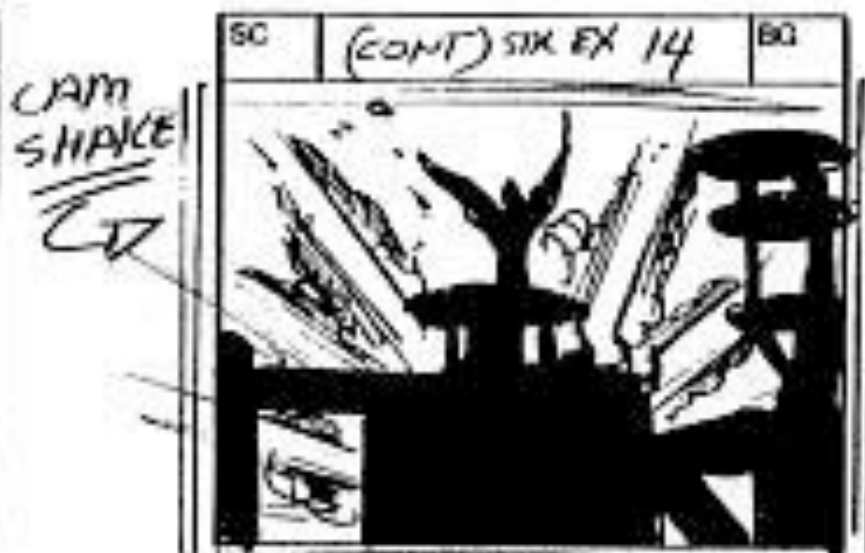

THE SLED CRASHES FROM  
BEYOND BUILDINGS.

10



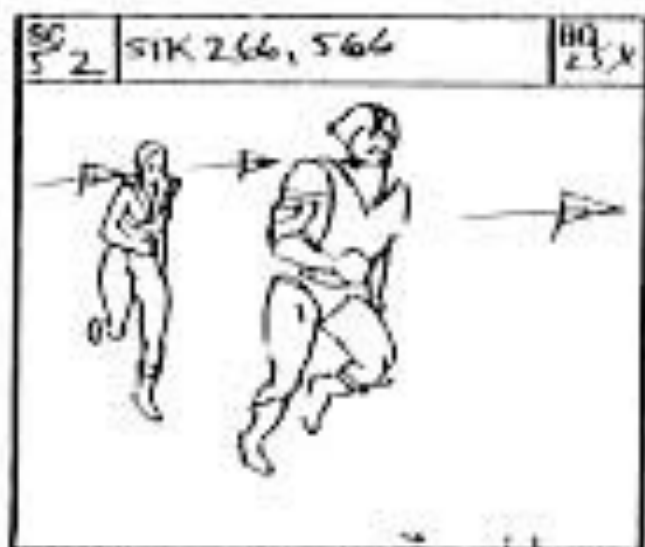

MMA, FOLLOWED BY TEELA THRU SC - HOLD A BEAT ON BG.

TEELA INTO SC



ON THE MAN RECOVERING INHURT FROM WRECKAGE.

TEELA  
Ee man are you all right?



FLD CUT

HM INTO SC, BRUSHES BACK, MUSED HIM - SMILES

EE MAN  
Just messed up my hair!

(B) POS

MU-16

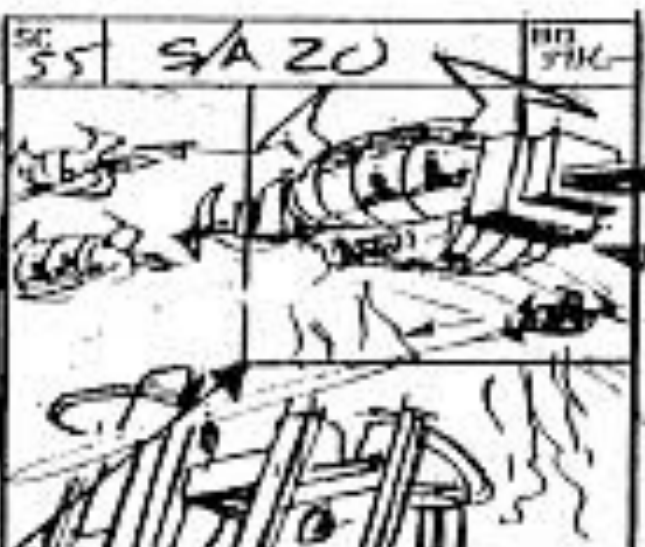

TRY IN ON SHIP - NO RAY FX -

5X (HOLD)

INTO SC

UL-20X

STK FLAMES



P.O.V. FROM SCOPE AS

4X

SLOW SKY PAN (B) POS

NOTE: REPEG STRATOS IN CENTER OF SHOT IF NEEDED

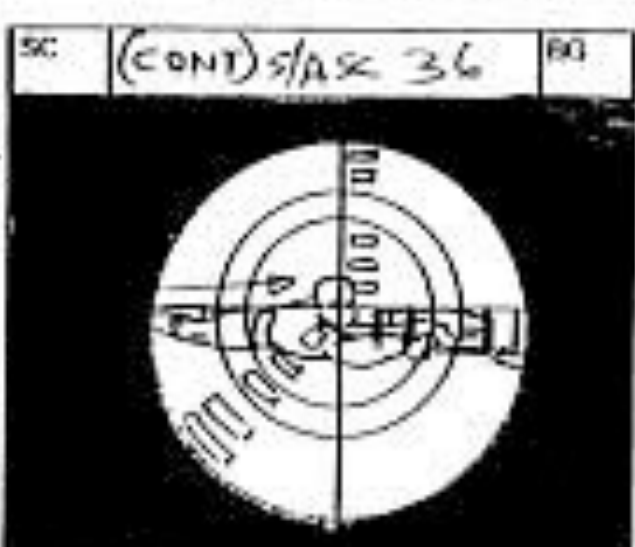

STRAPOS, CARRYING THE STAFF GAINS INTO SC, HOLDS POS.

PAN SKY

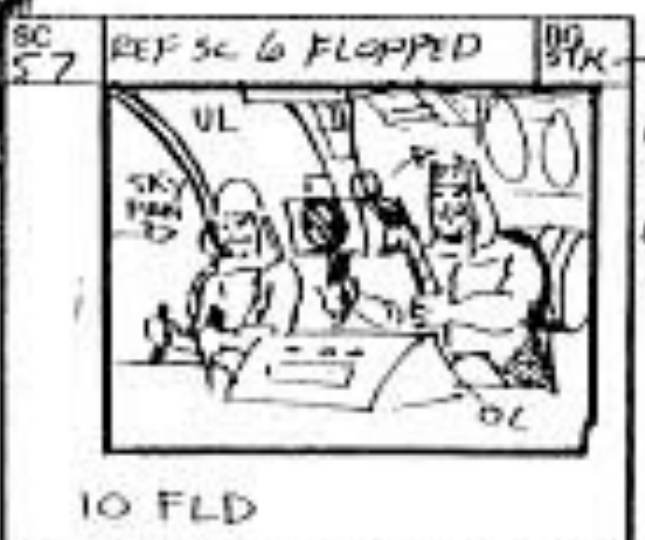

INT-TORG-SHIP - WE SEE PILOT AND VON. VON LOOKS UP FROM BEHIND SCOPE AND BREAKS INTO

**EVIL** SMILE --

4X

UL 57X

OL 57X

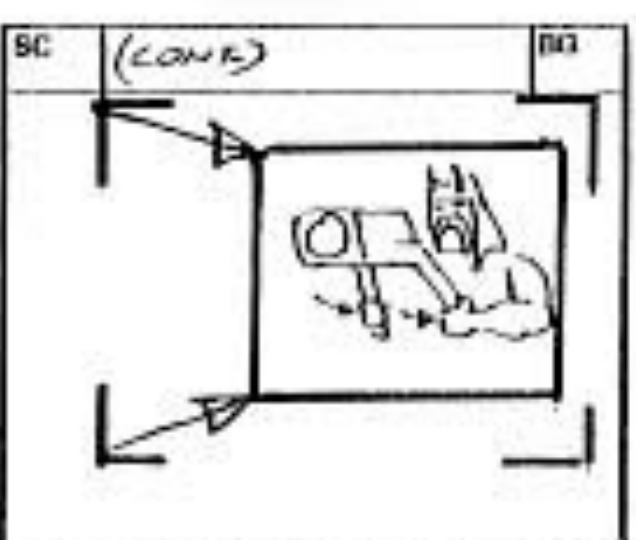

TRK IN PAST AS HE PULLS BACK ON CONTROL LEVELS.



||

DROP DIAL: SCRIPT SC'S 67-69

LO: SEE SC 313 FOR REF

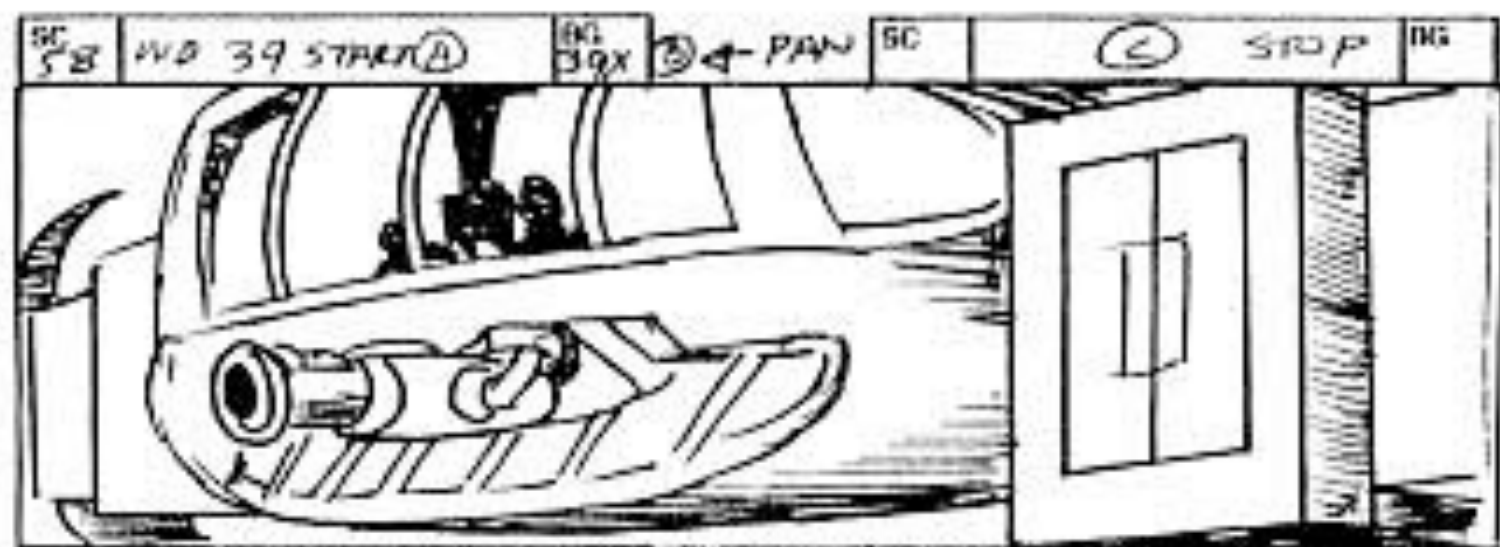

EDGE ON SHIP - PAN TO IT'S (A) FRONT PANEL SECTION -

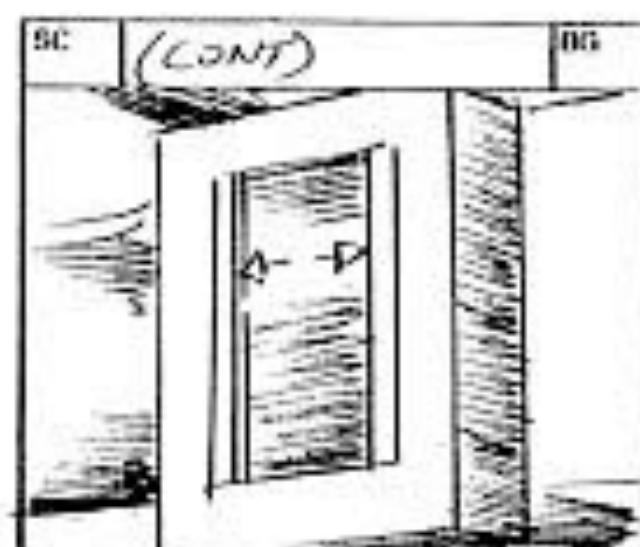

DOORS SLIDE OPEN -

MJJ-16

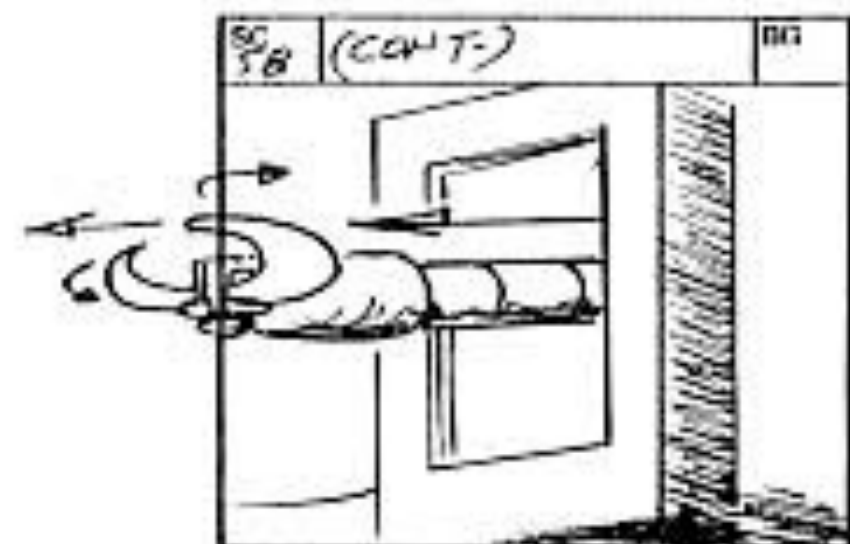

GIANT MECHANICAL CLAW REACHES FROM INSIDE AND STRETCHES A BEAT TO OS -



STRAUS, HOLDING STAFF FLIES INTO SC AND IS CAUGHT BY CLAW -

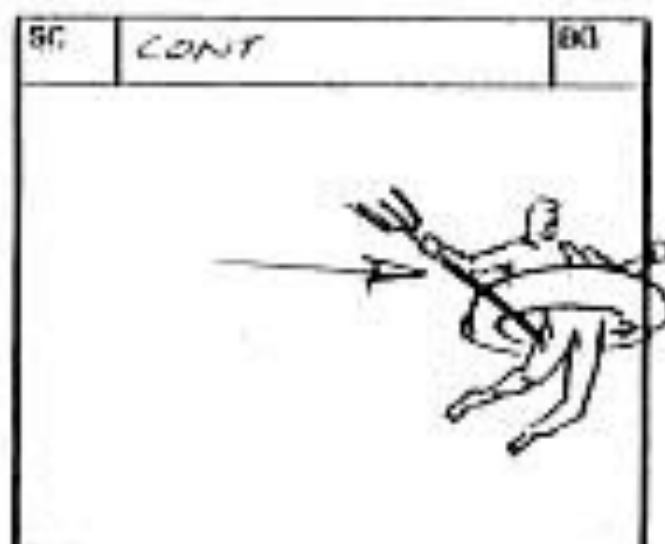

IT TAKES HIM OS -

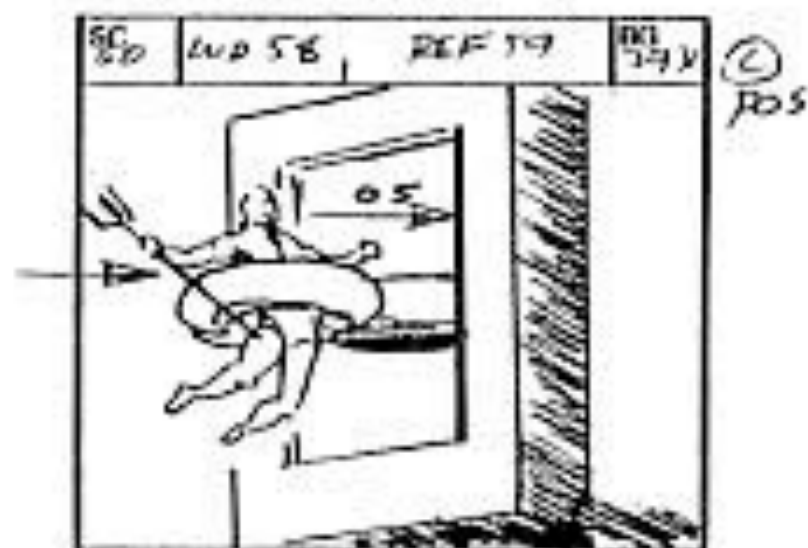

CLAW PULLS STRAUS AND STAFF INTO SHIP -

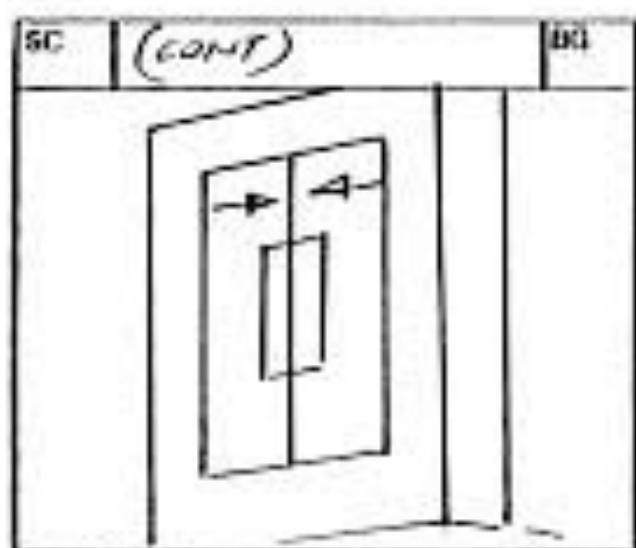

DOORS CLOSE -

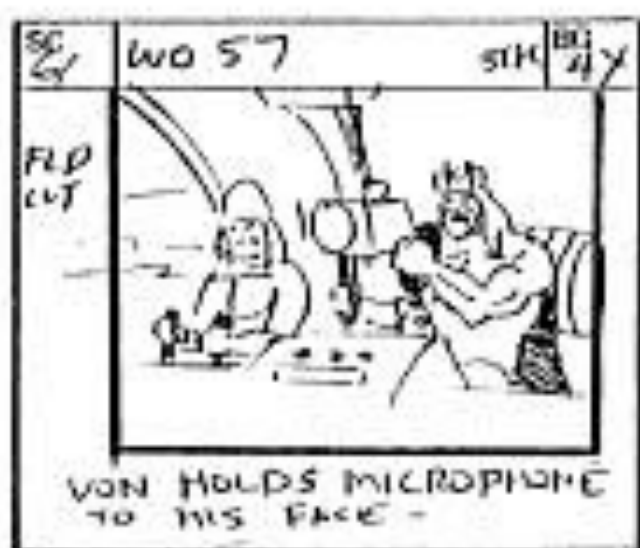

VON HOLDS MICROPHONE TO HIS FACE -

BEGIN SKY PAN ON SOLDIERS  
←  
UL 57X  
OL 57X

12

VON (AMPLIFIED)  
Tug soldiers, fall back!



STK  
FLAMES  
5  
↳



SC 62 (A 20) (REV ANIM) INQ 21L  
VON'S SHIP PULLS BACK AS -  
VON (OB) (con't)  
(AMPLIFIED)  
We have captured the Staff that will free Nulkrom!

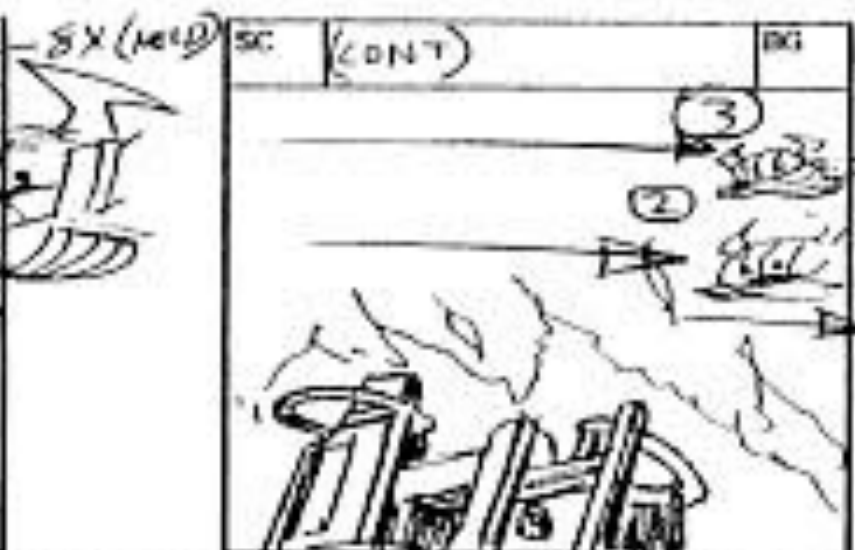

SC (CONT) INQ  
OTHER SHIPS FOLLOW -

TRK  
CUT  
↳



SC 63 STK 1 INQ 26X  
ON HIM AND COMPANY LOOKING UP AT OS TORR SHIPS -

MU-16  
FILMATION STUDIOS

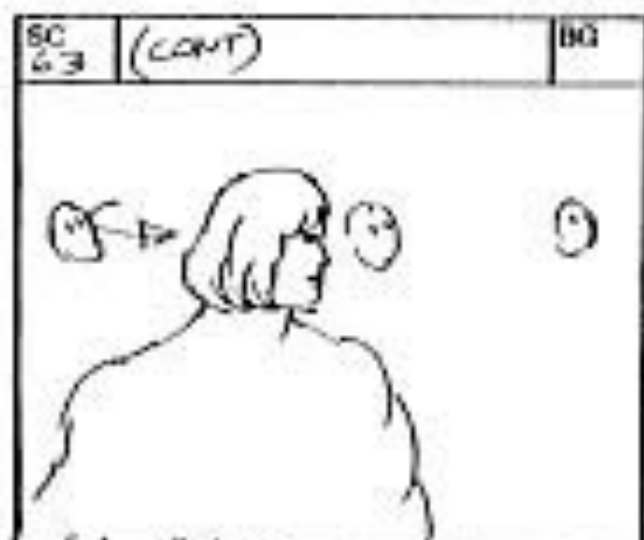

SC 63 (CONT) INQ  
HE MAN (LINES) TOWARDS DELORA  
HE MAN  
Who were those creatures, Delora?

HOOK  
UP  
DELORA  
↳



SC 64 REF STK 201 INQ 257  
FLD CUT  
DELORA  
I have no idea, He Man.  
All I know is that they've taken Stratos!

FLD  
CUT  
↳



SC 65 STK 502, 3 INQ 272  
HM TURNS TO MAA  
MAA AT ARMU  
One of them mentioned "Nulkrom."

A  
POS



SC 66 STK 2 INQ 18X  
DELORA  
Nulkrom. The sorceress might know that name.

SLIGHT  
FLD  
PAN  
↳



SC (CONT) REF STK 201A INQ  
HM TURNS TO DELORA  
HE MAN (con't)  
Delora, I promise you -- I'll bring Stratos back.

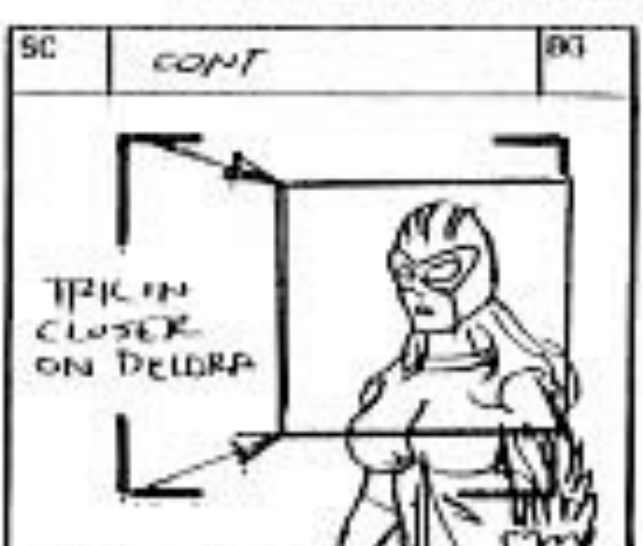

SC (CONT) INQ  
DELORA  
Stratos is brother, He Man -- I'm going with you!

13



BE MAN  
Very well!



93  
TILT  
CA



TRK IN ON TOROS  
CAVE -

Pos  
Diss  
=

91-111



INT - CAVE DEN - PAN TO (B) POS. THE TOROS AND SKELETON WATCH THE HELPLESS STRATOS, WHO IS CHAINED TO A MOUNTAIN - SKELETON (ON) So tell me, Flop of the birdmen...

STAFF  
OF  
AVION  
CA

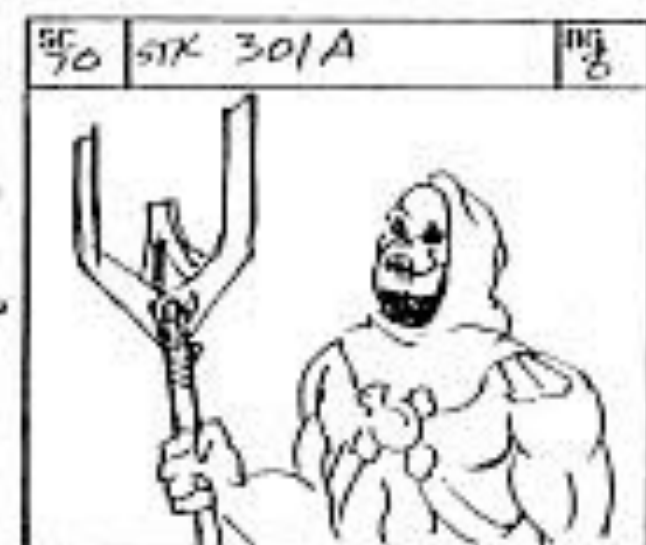

SHEL LOOKING UP AT STRATOS

SKELETON  
How do I use this Staff?



CLOSER ON CHAINED STRATOS -

STRATOS  
I'll never tell you!

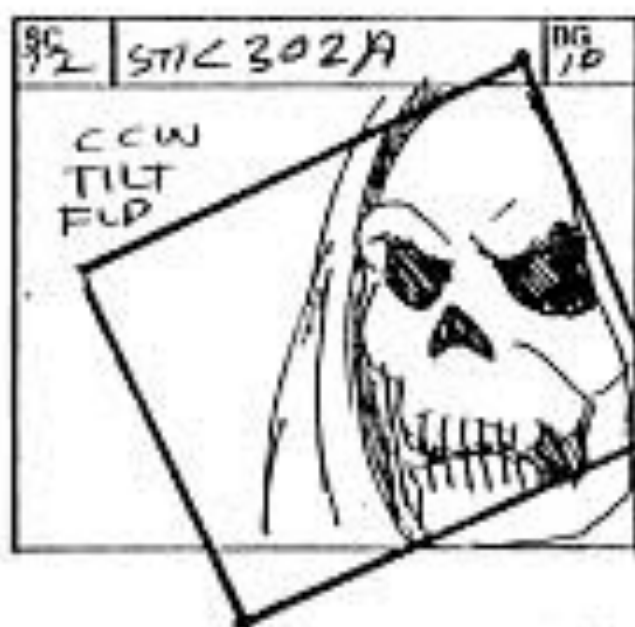

SKELETON  
Oh, you will...

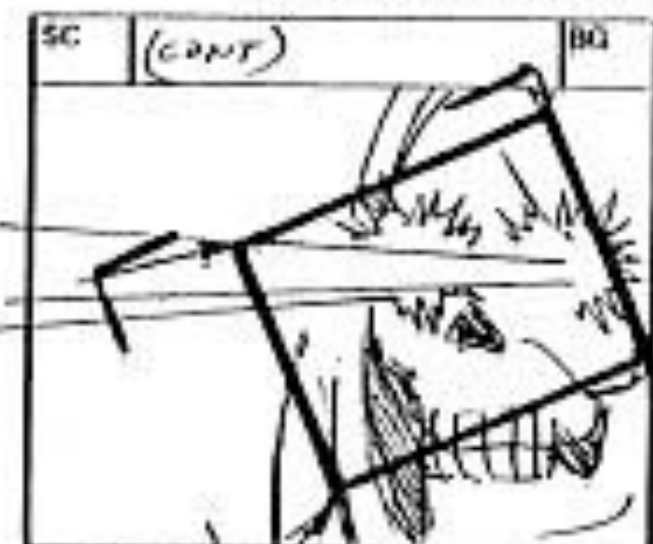

TRK IN CLOSER AS RAIS.  
FIRE FROM HIS EYES -

14



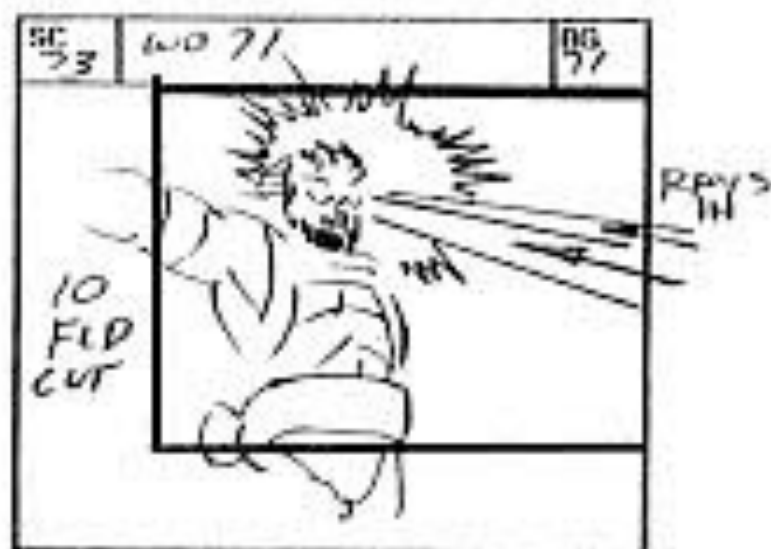

STRATOS REACTS TO RAYS -

SKELETON (CG) (con't)  
You most certainly will!

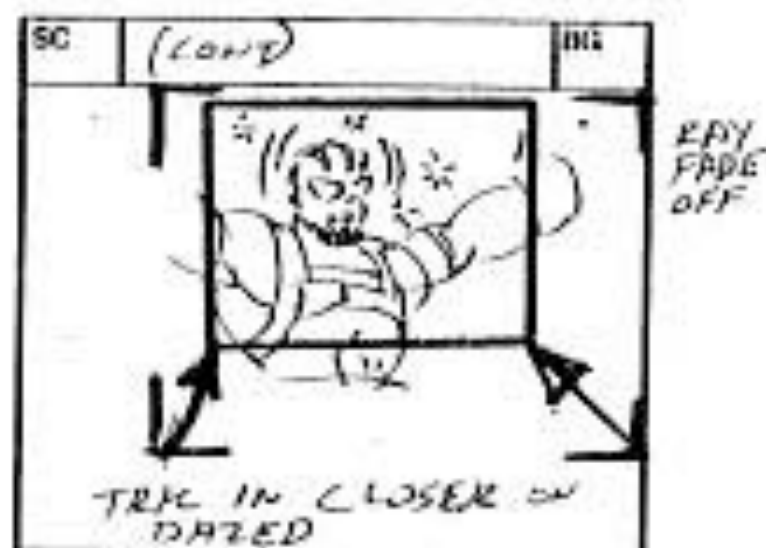

EYE  
FADE  
OFF



ON STRATOS' (B) EYE AS

OL  
74  
SET UP  
TO W/W  
SC 161  
45

MU-16

FILMATION STUDIOS

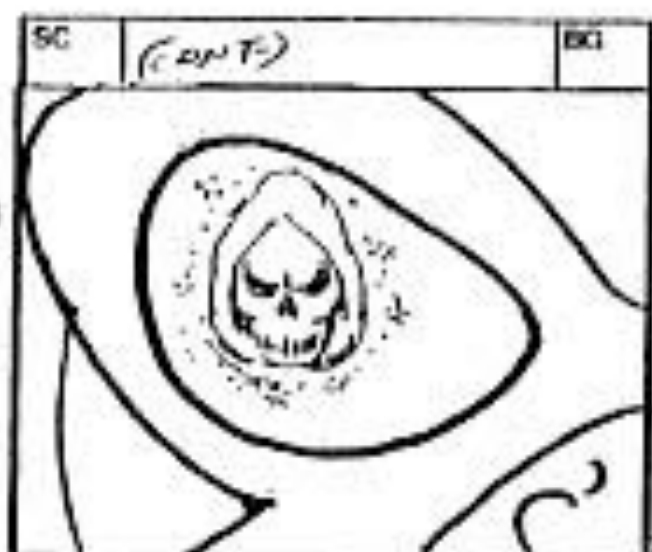

SOFT  
DISTURBISH  
AROUND  
SKEL

FACE OF SIKEL FADES IN



OL  
76  
MU-5  
HOOK  
UP HERE  
4 C13  
83, 89

INT-SORCERER LAIR - TAK IN  
ON HEROES - HE MAN, RAM MAN, TELLA,  
ORIC, MAN AT ARMS

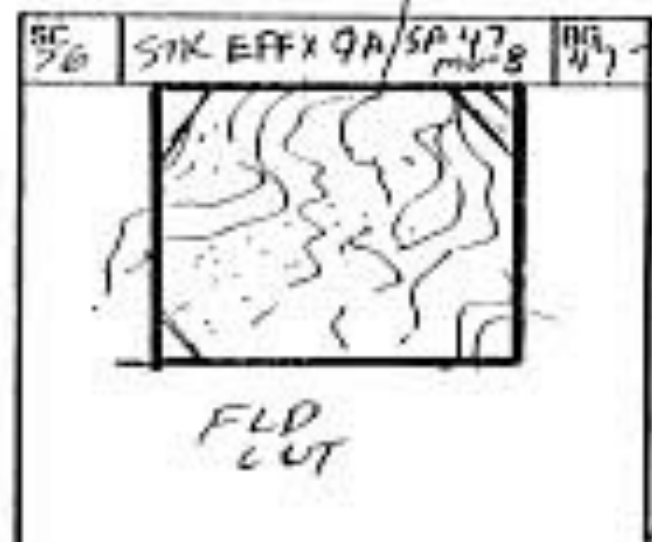

ON MASSIVE MIRROR AS  
FX DISSOLVED TO SWIRLS  
OF STATIC



UPSHOT - MOLKROM ROARS  
WILDLY AS HEAD REARS -

MOLKROM  
(BELLOW)



LONGER IN MOLKROM. HE FIRES  
RAYS FROM EYES TO AS AS GROUP  
OF TOROS WATCH -

SORCERER (CG)  
This is Molkrom

MU-4  
OL 48  
MU-8

15



ON ROCK AS MULKROM'S RAYS STRIKE IT -

SC 59 H279 PG 143 MU-4  
OL48 MU-8



TOP HALF DISSOLVES.

SORCERESS (OB) (cont)  
With him, the Torgs were invisible.



FULL TRK OUT  
BC  
REF 47, MU-8

SC 60 REF 47, MU-8 PG 147 MU-8  
MULKROM  
FADES OFF  
SORCERESS

SORCERESS (CONT) (VO)  
So the Torgs used their magic to imprison him deep in the caves, in which the Torgs live!

91-11



FADE ON STATIC MORRIS BY ON MIRROR -

HOP UP  
TEELA  
AND  
ORKO



ORKO LEANS OVER TEELA'S SHOULDER - DOES A TAKE

ORCO Caves?



TEELA SMILES AT ORKO AS HE DOUBLE TAKES AT CAMERA

ORKO (CONT) of that! I don't like the sound



SORCERESS  
The staff of Avlon can free Mulkrom.



TRK IN FROM SORCERESS CLOSER TO HEROES -

SORCERESS (OB) (cont)  
And Mulkrom has the power to destroy Graykull!



ORCO  
Then we'd better start moving!

16





SORCERESS  
There's something even worse!



ORZO  
Do we really have to know about [E]?

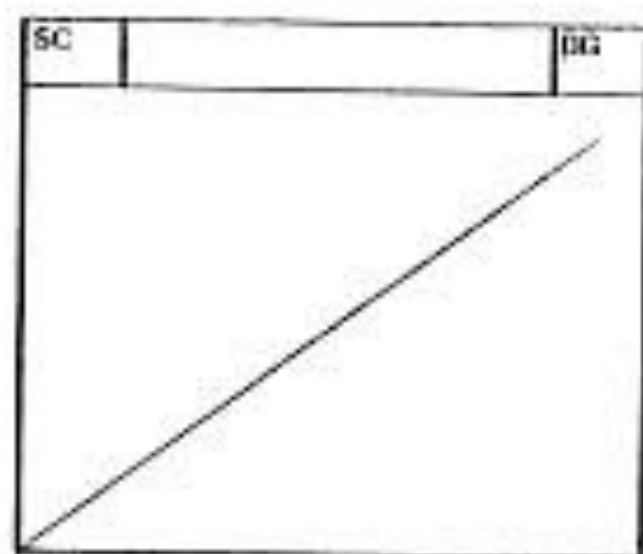

21-114

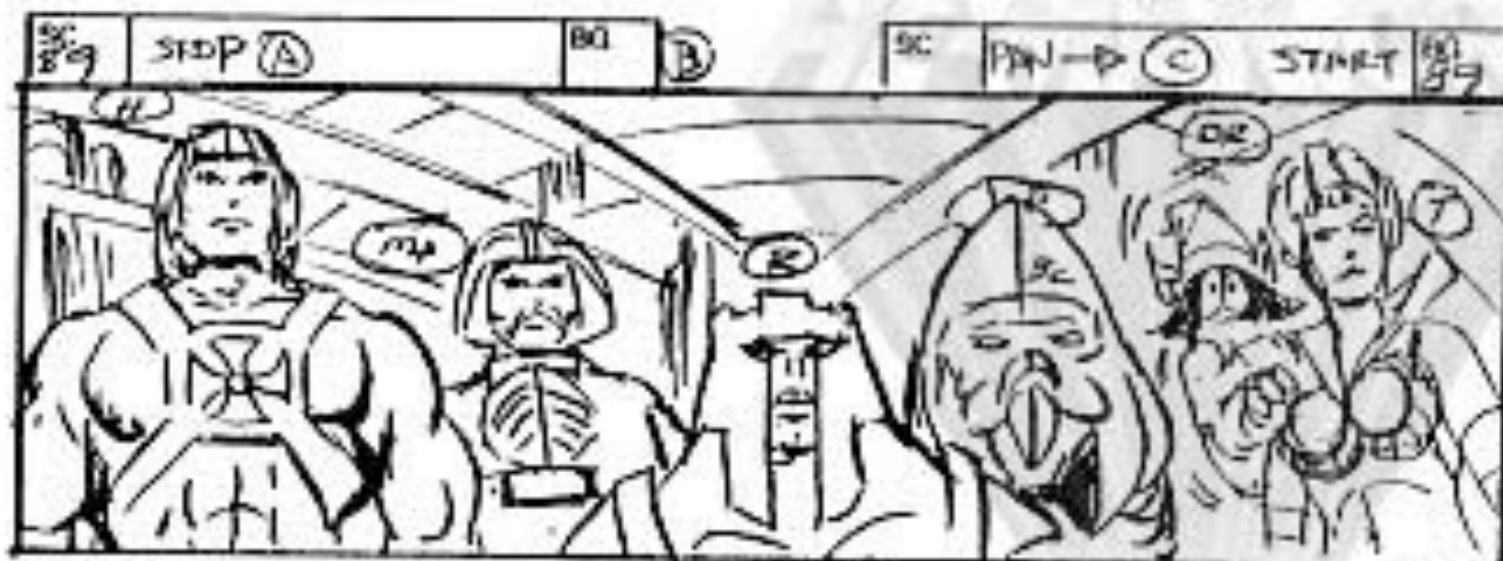

PAN ALONG UPSHOT OF OUR HEROES - THEY LOOK CONCERN

SORCERESS (w)  
Once the staff is used for evil, it must be used quickly to undo that evil -- or it will explode!



SORCERESS (con't)  
And take half of Eternia with it!

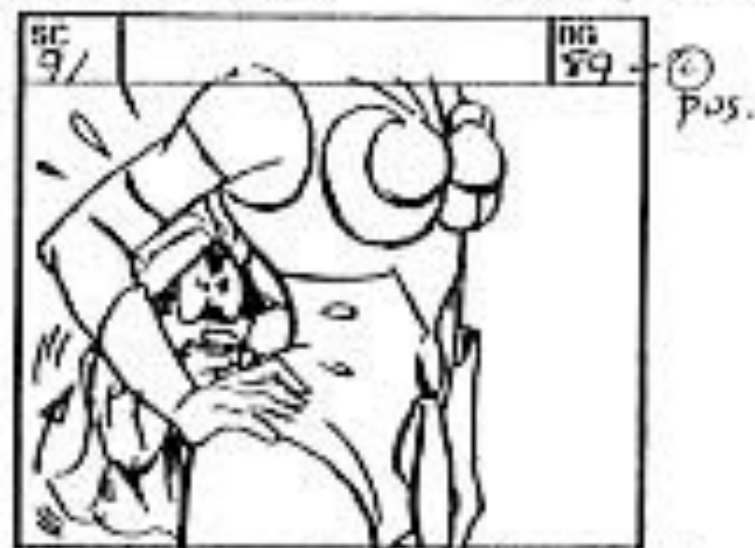

CLOSE UP TECLA AS ORZO PEEKS FROM UNDER HER ARM  
ORZO  
Couldn't we be on the other half?

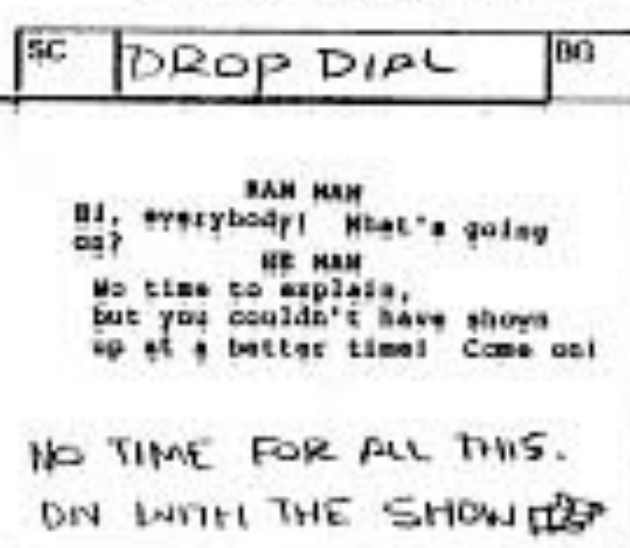

17



TO BE MADE STK



ATTACK TRAK WHEELS AWAY FROM CAM

A-D BIKE (HOLD) (2) 100

A-D BIKE VL 92 (10)

MAKE TRAK STK



LONG ON ATTACK TRAK AS IT GAINS INTO SC -

PAN UP

PAN UP AT SET SPEED

TRK 12

MU-16



INT- ATTACK TRAK - WE SEE DEBRA, BC, TEELA, 2 PM MON, HM, ORKO AND MA'A.

DEBRA The Torge live somewhere in these caves!



TRK IN DOWN TUNNEL AS A STALAGMITE BEGINS TO MOVE...

DARK CAVERN

TRK 12

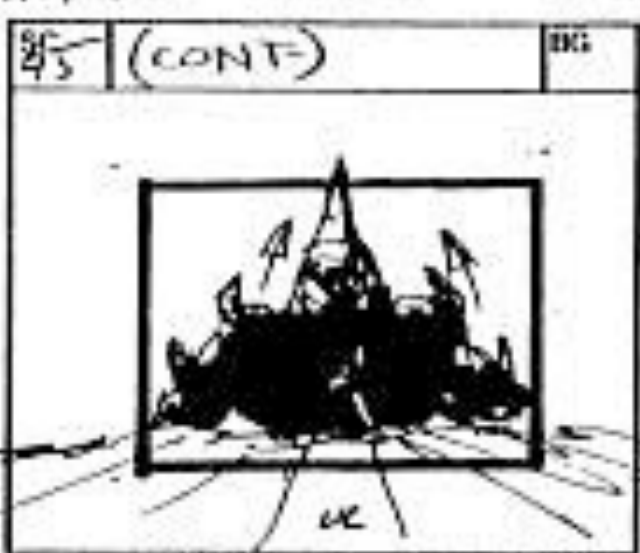

PHD REVEALS ITSELF AS A SHADOWY CAVE MONSTER!!

NO SC 96

FLD CUT



RAM TAKES

RAM HAS they're not the only things!

CARD INT ATTACK TRAK ANIM: START SC WY FOOT ALREADY HERE

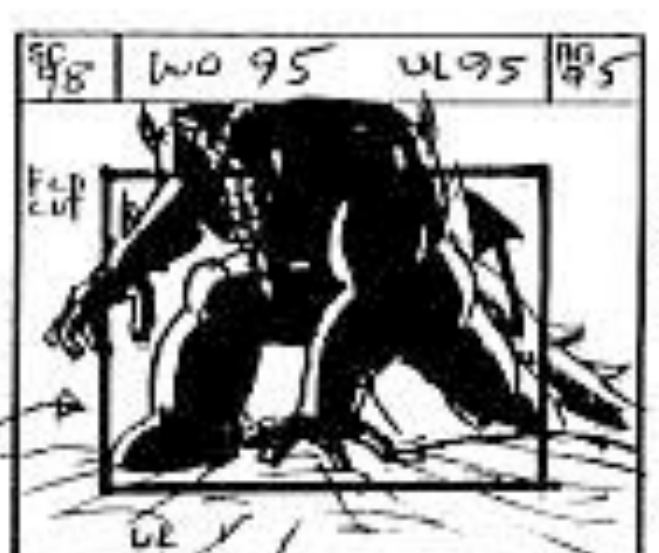

PHYSTIK RAISES SLIGHTLY OVER LEDGE -

Look!

DEBRA (VO)

MONSTER STILL REMAIN SHADOWY HERE

18





SC 99  
 CU OF ANGRY BEAST.  
 CAVE MONSTER (THUMPING)

LS - DARK CAVERNS



SC 100 WO 94 UL 94 BG 92  
 TRK IN ON HM AS GROUP DOES SHOCK TAKE -

BIG PAN

ZIP TRK CV

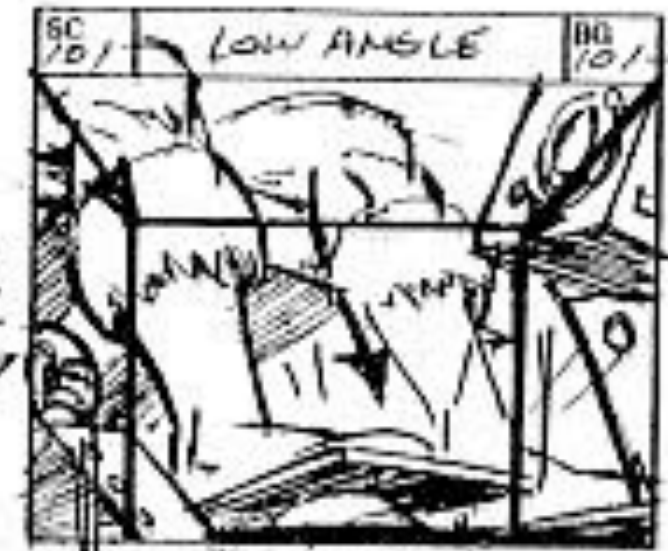

SC 101 LOW ANGLE BG 101  
 CLOSE ON HE MAN'S FOOT AS IT SLAMS ON THE BRAKE!!

INT REPTER TRK

MU-116  
 FILMATION STUDIOS

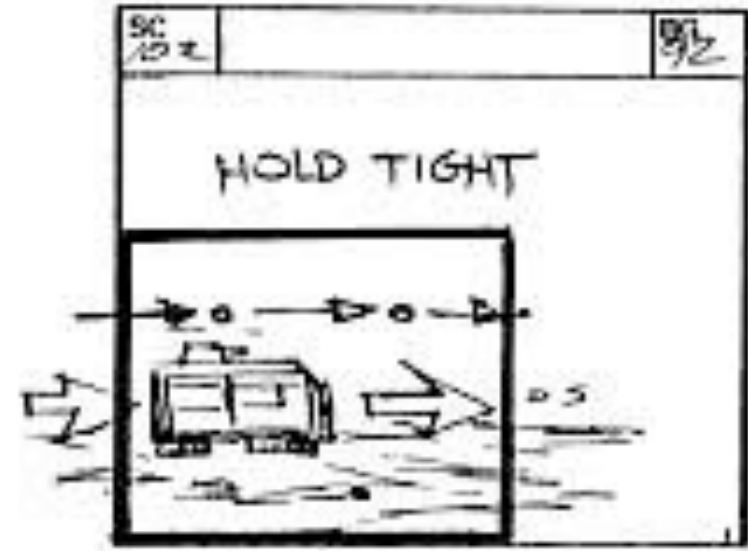

SC 102 BG 92  
 HOLD TIGHT  
 EXT LONG SHOT - ATTACK TRAK SKIPS THRU SC, TRYING TO STOP -

105

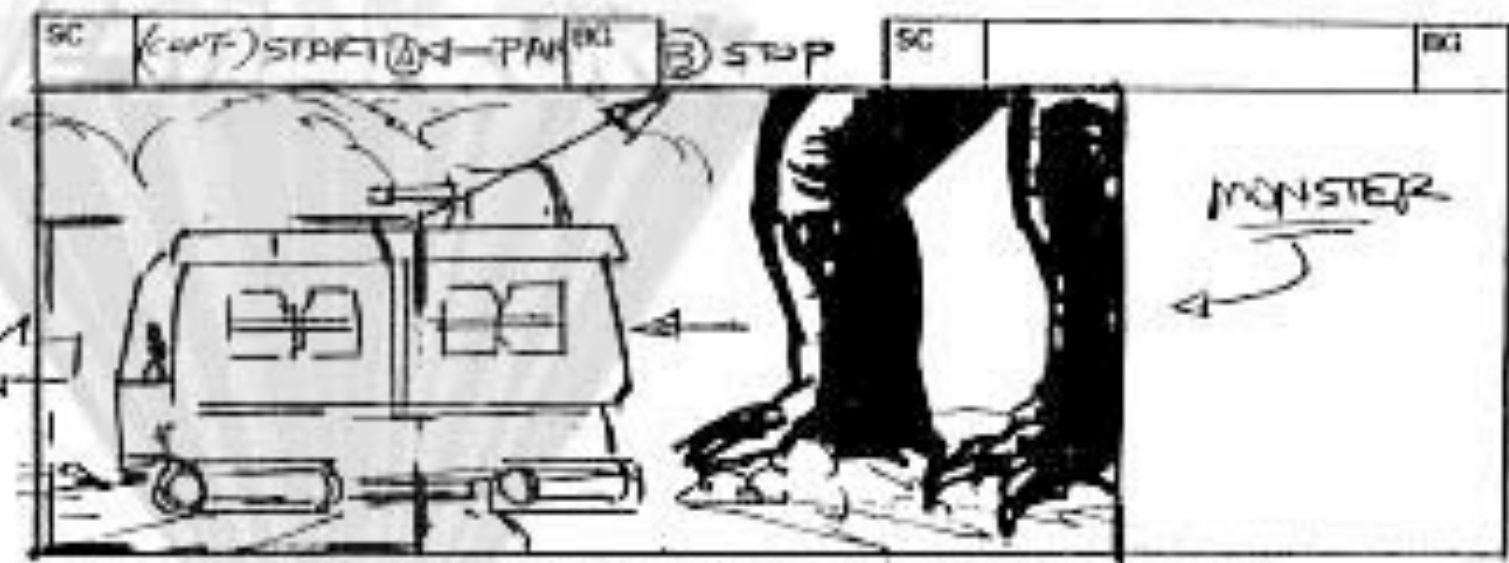

SC (CONT) START PAN - PAN STOP  
 PAN AND TRK OUT AS IT PASSES BACK THRU SC IN FOREGROUND - STOP PAN AT MONSTER'S FEET.

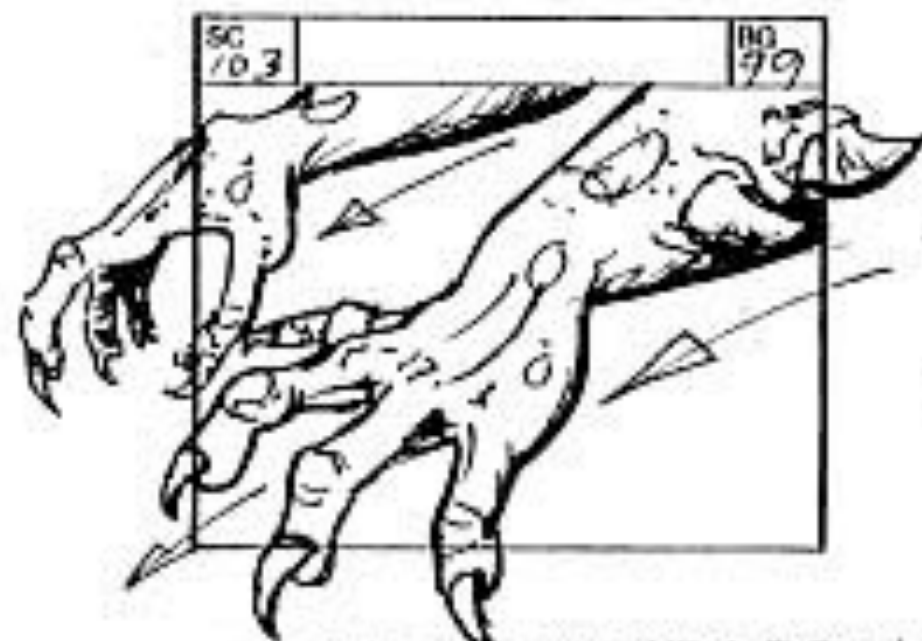

SC 103 BG 99  
 CAVE MONSTER REACHES DOWN OS -

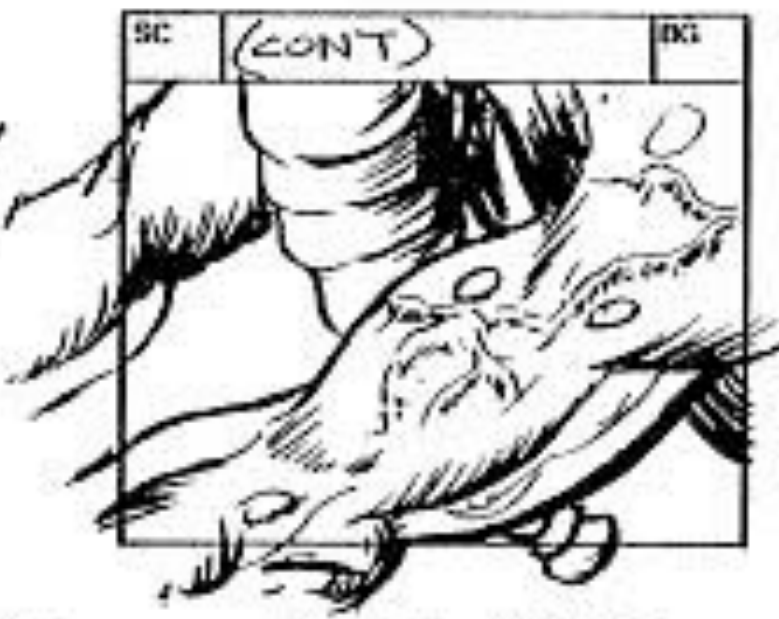

SC (CONT) BG  
 HOLDS A BEAT -

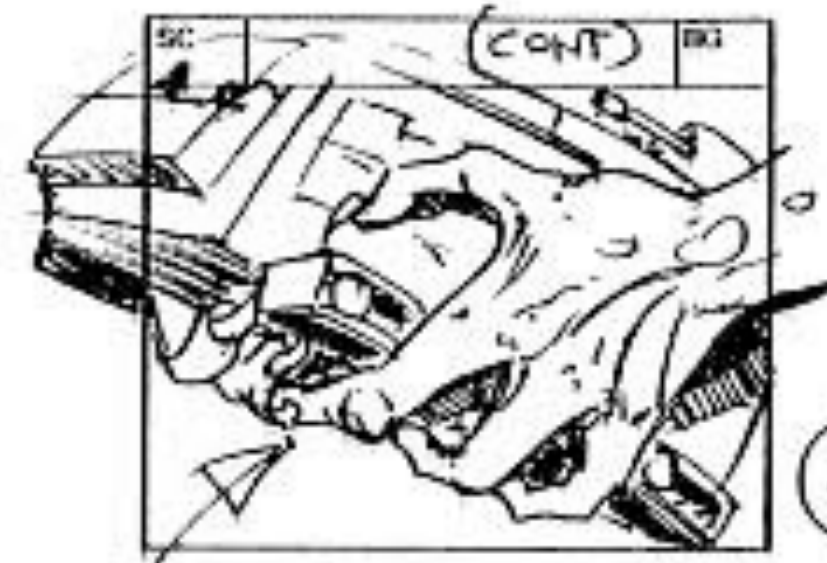

SC (CONT) BG  
 IT LIFTS ATTACK TRAK UP INTO SC -

19

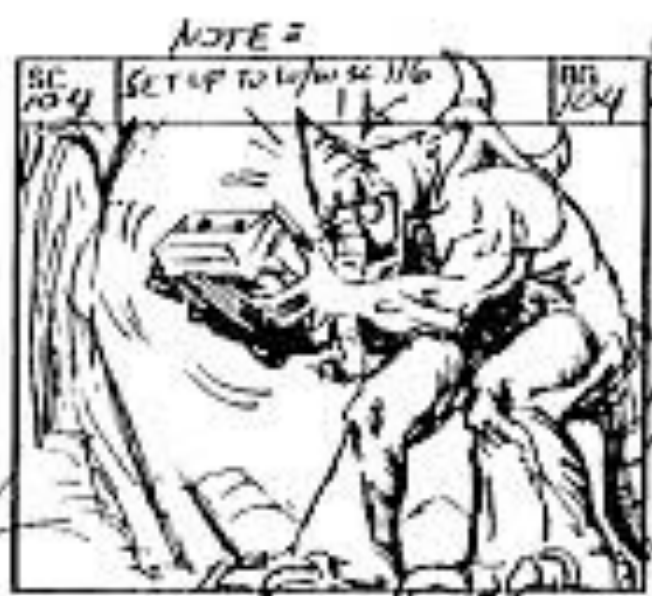

LOW ANGLE - WE SEE FULL FIGURE OF MONSTER AS IT SHAKES ATTACK TRAK.

UL-OL  
54 MU-7  
CONTINUOUS  
CAM  
SHAKES

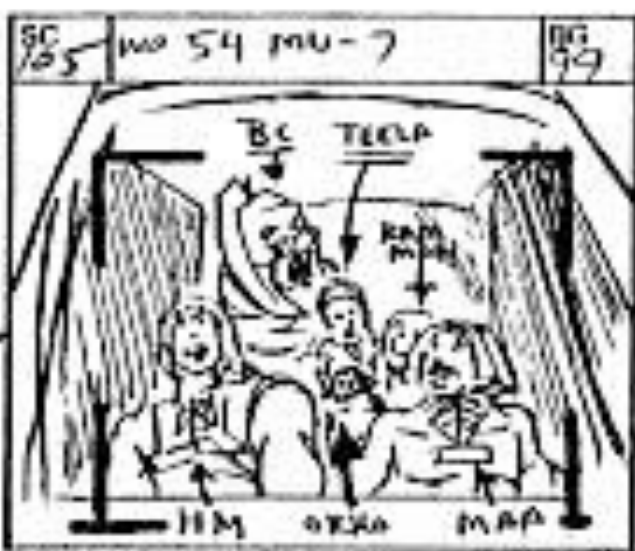

OH HEROES BEING SHAKED!!



HM LOOKS DOWN

CARD  
BEAT-  
STOP  
CAM  
SHAKE

11-116

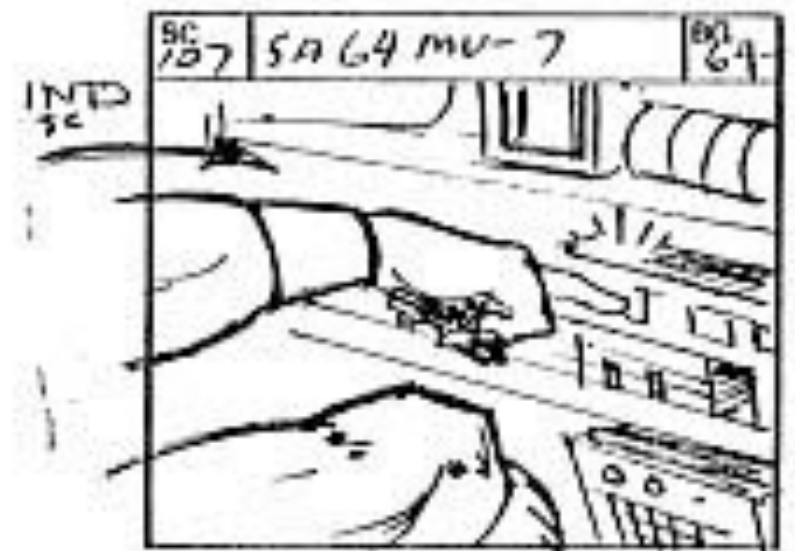

INT-A-TRAK - HE MAN - PUSHES BUTTON.

MU 7  
REF  
FX SC  
65  
MU-7



ELECTRICITY ENGULFS MONSTER.

FADE  
OFF  
FX  
CD

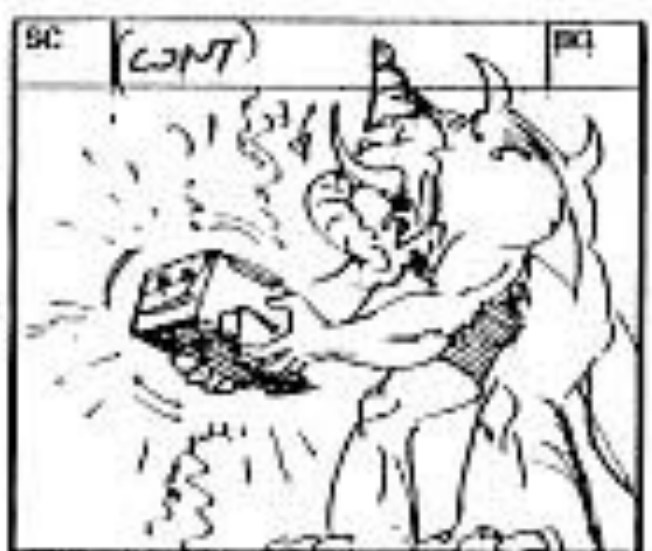

MONSTER STANDS DAZED AND SHAKY AS FX FADE.

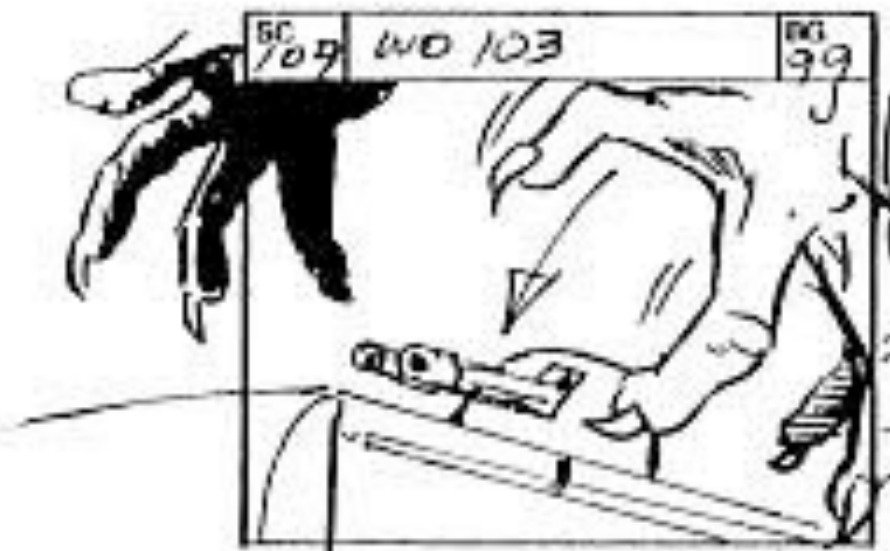

MONSTER DROPS A-TRAK - IT FALLS OS -

HEAVY  
CAM  
SHAKE

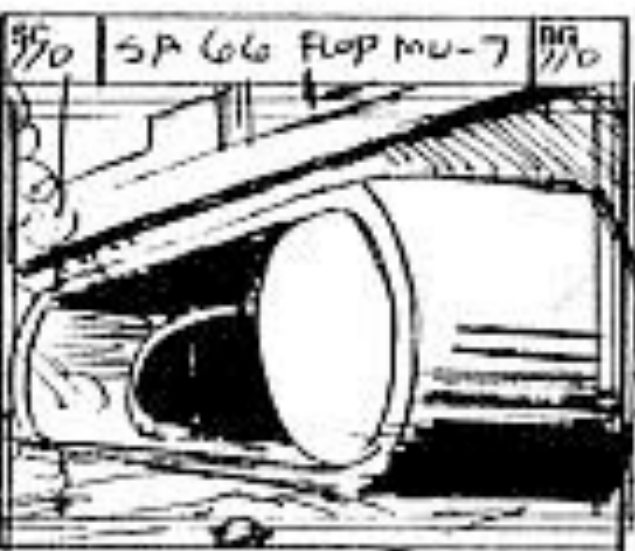

A-TRAK DROPS INTO SL - CFX: METAL CRASH!!



CAVE MONSTER (THUNDERING)



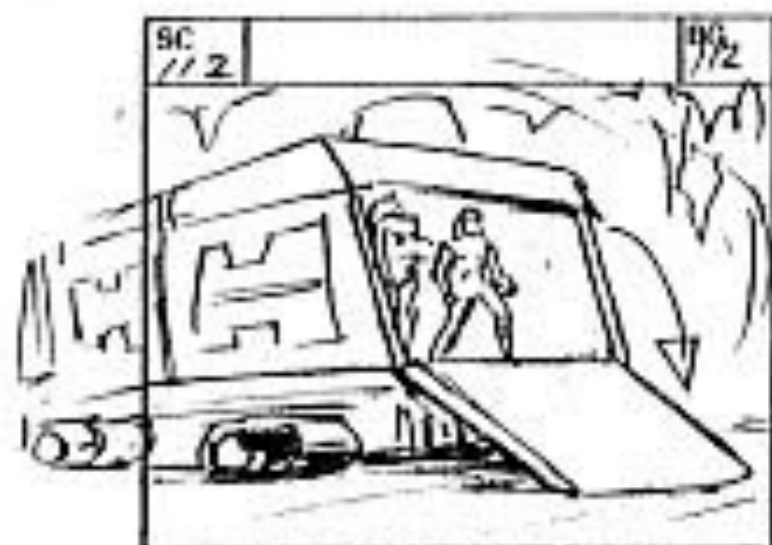

EXT-REAR OF A-TRACK -  
DOOR LEVERS OPEN TO REVEAL  
HE MAN AND BC.

FLD  
CUT  
D



HE MAN LOOKS UP AS SHADOW  
COVERS HIM - CAVE MONSTER (W)  
(TRUMPETING)



MONSTER TOWERS OVER  
A-TRACK - CAVE MONSTER  
ANGRY!! (TRUMPETING)

(A)

MI-16



FLD  
CUT  
D

HM LOOKS DOWN



PAN FROM MONSTER'S FEET  
TO ITS TAIL

HE MAN (OG)  
That's just what I need!



CLOSER ON MONSTER'S FEET AS  
HM BING THRU CC BETWEEN THEM

(21)

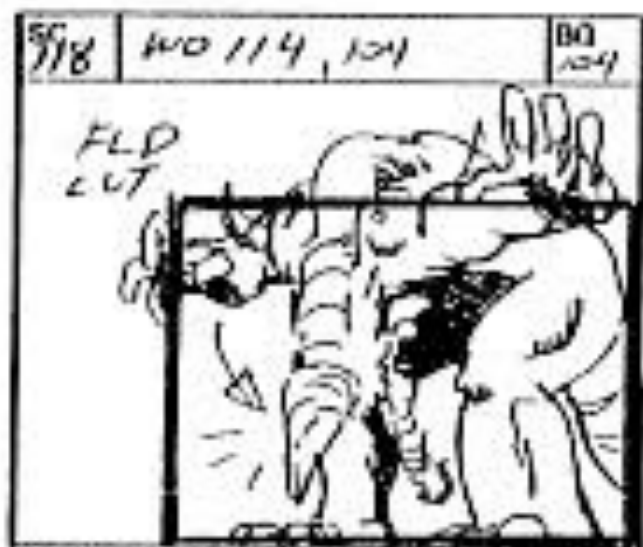

SURPRISED MONSTER TRIES TO FIND HEMAN - BUT..

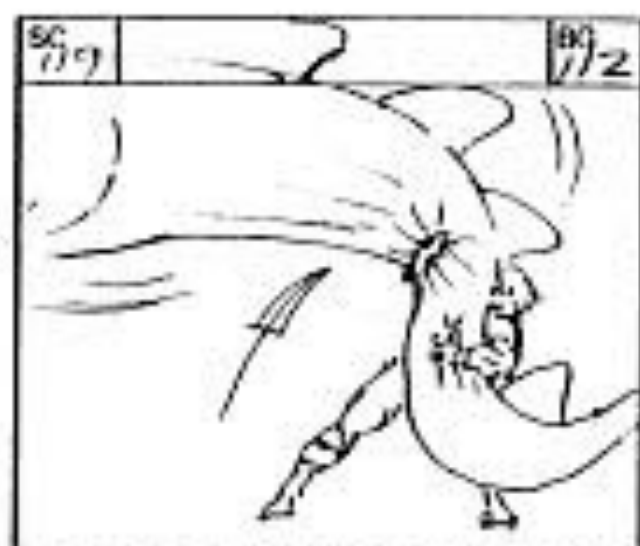

HE MAN PULLS ITS TAIL

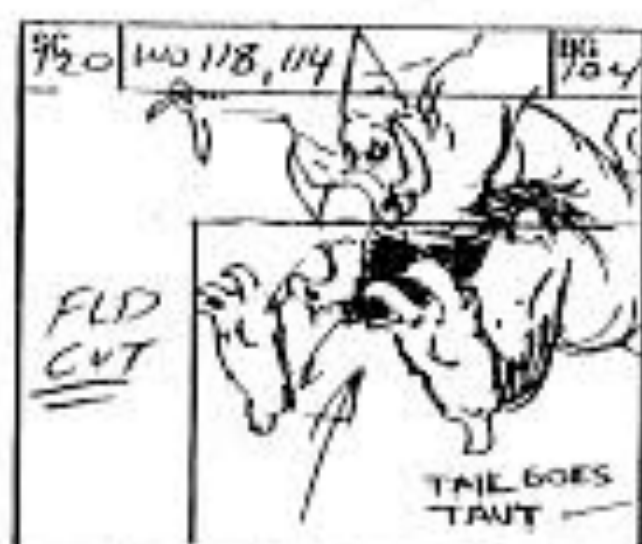

OS HM LIFTS MONSTER

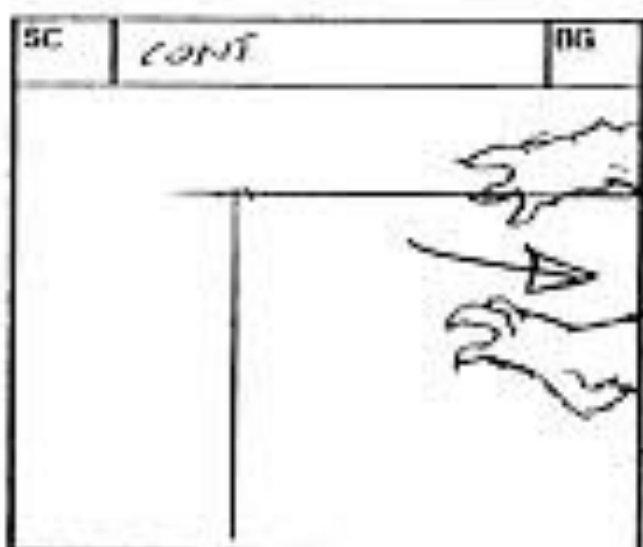

SWINGS IT OS



HE MAN SWINGS MONSTER AROUND AND AROUND BY ITS TAIL -- UNTIL --

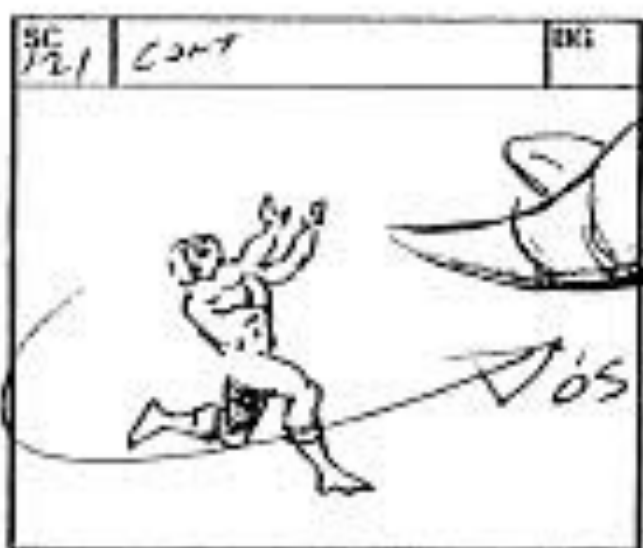
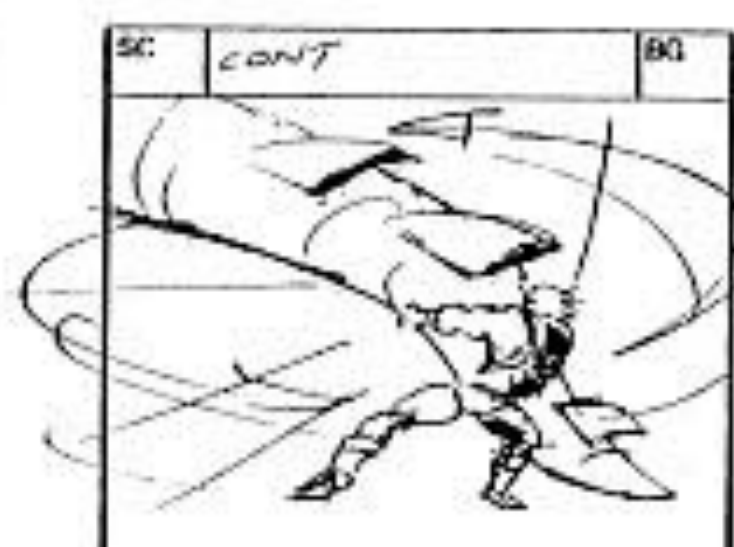

HE LETS IT FLY!!

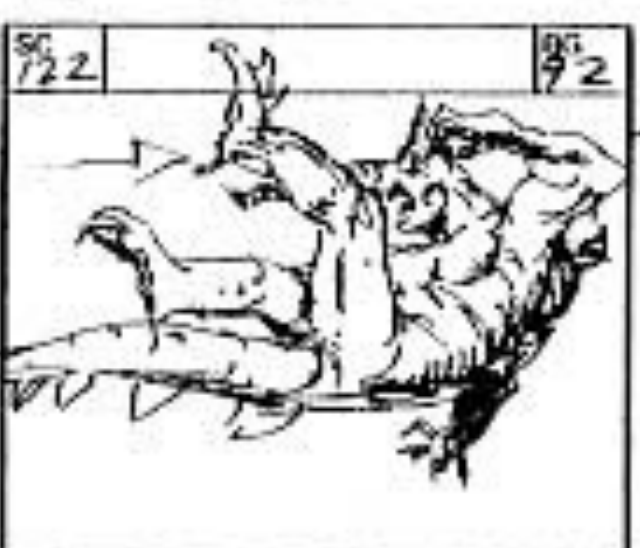

MONSTER GAINS THRU SKY

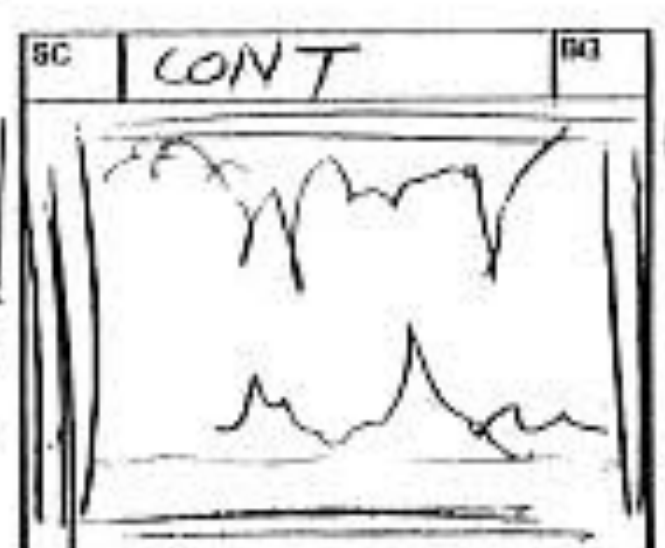

HOLD ON BO AS WE HEAR... CEXT OS

MI-15



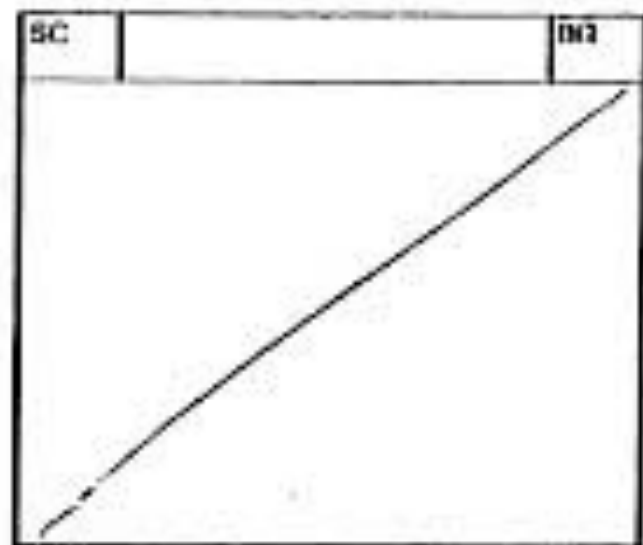

ON DAZED MONSTER -  
UNHURT BUT NO LONGER  
A THREAT!



HM MOUNTS BC.

205  
HOLD  
400  
600  
MU-115



OUR GROUP OF HEROES REACT  
TO OS -  
CAVE MONSTER  
(TRUMPETING)

NOTE:  
ANIMATION  
ON HEROES  
ONLY!

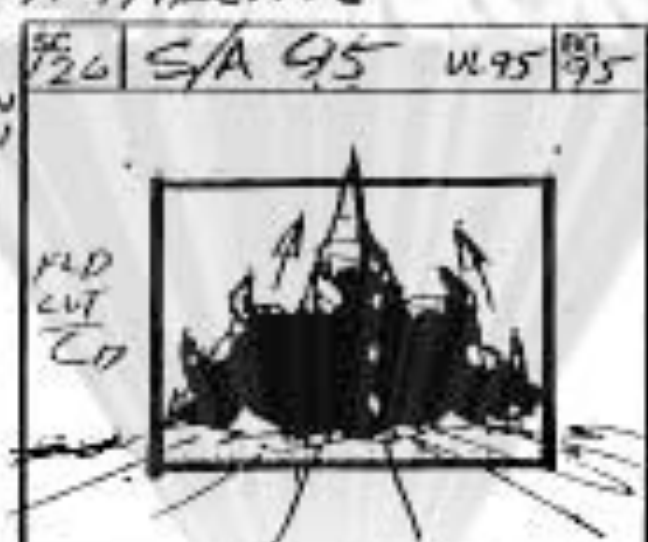

ANOTHER MONSTER RISES.



HM, BC AND OTHERS IN TO CAVE -  
THIS WAY! BE HIM (VO)

OL-OL  
127

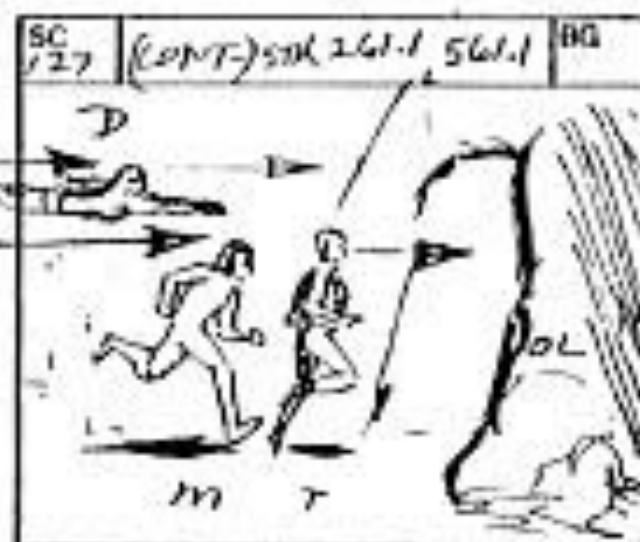

FOLLOWED QUICKLY BY TEELA,  
MAA, DELORD



AND RAM MAN...

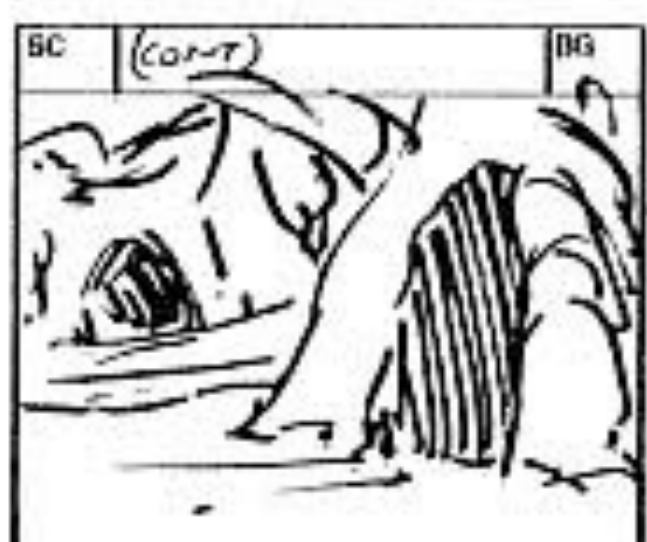

HOLD A BEAT ON BC

23

NOTE / TALOPA HOVERS

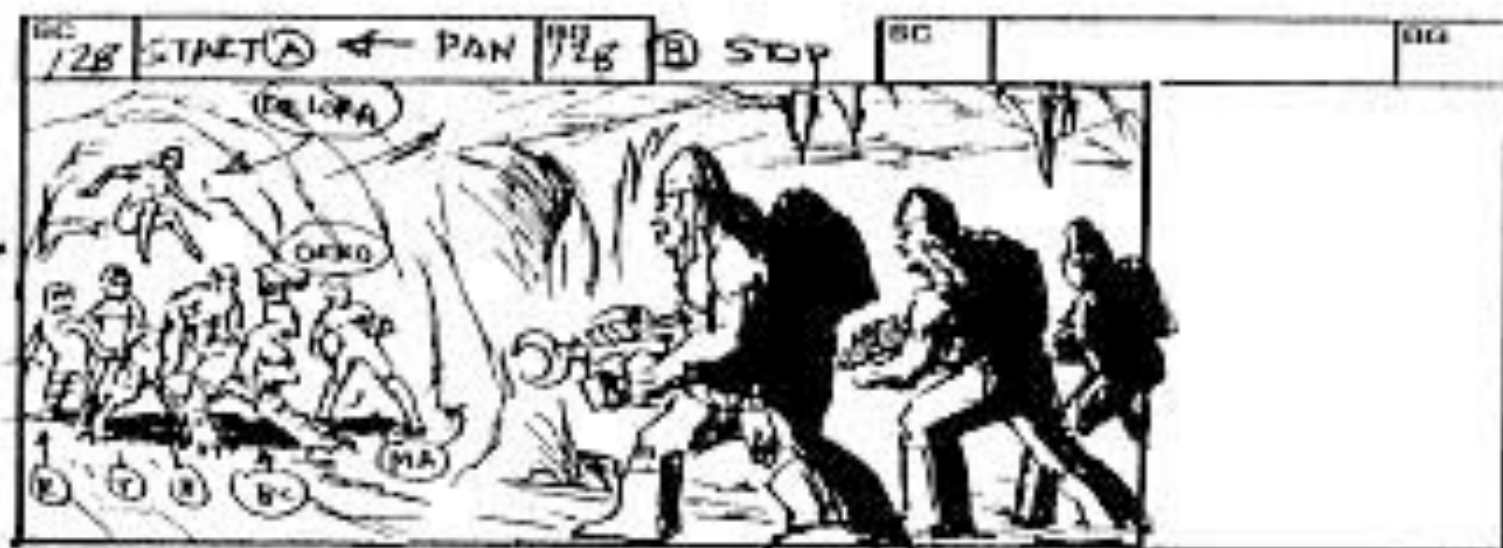

128 START (A) ← PAN 128 (B) STOP  
 PAN FROM SURPRISED HEROES TO THREE TORG SOLDIERS -  
 NOTE: BATTLE CAT IS CROUCHED FOR ATTACK

SEX: BATTLE CAT GROWL



129 THE TORGs RAISE WEAPONS -

CAVE WALL  
 10' W/ SC  
 131

HOOK  
 ↓  
 ↑

ILLUSTRATION  
 9-1-76

TEELA (VO)  
 The Target



130 STK 803 113  
 BATTLECAT  
 Time for a fight!



131 TWO SC 112  
 ON TORGs AS CAVE WALL  
 SLIDES UP -

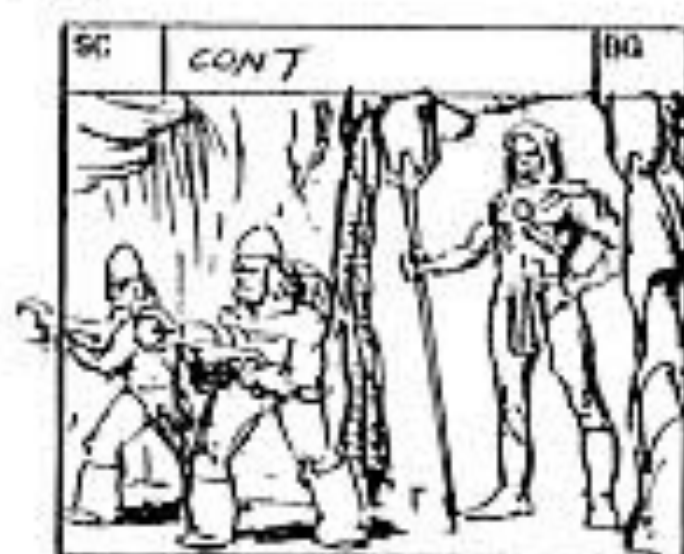

132 CONT 110  
 TO REVEAL SKELETON HOLDING  
 STAFF OF AVION

SKELETON  
 Gratitude, Be Man!

SKELETON  
 HOLDS  
 STAFF  
 OF  
 AVION



132 STK 301 A 104  
 BE MAN (VO) Skeleton!

(A) POS

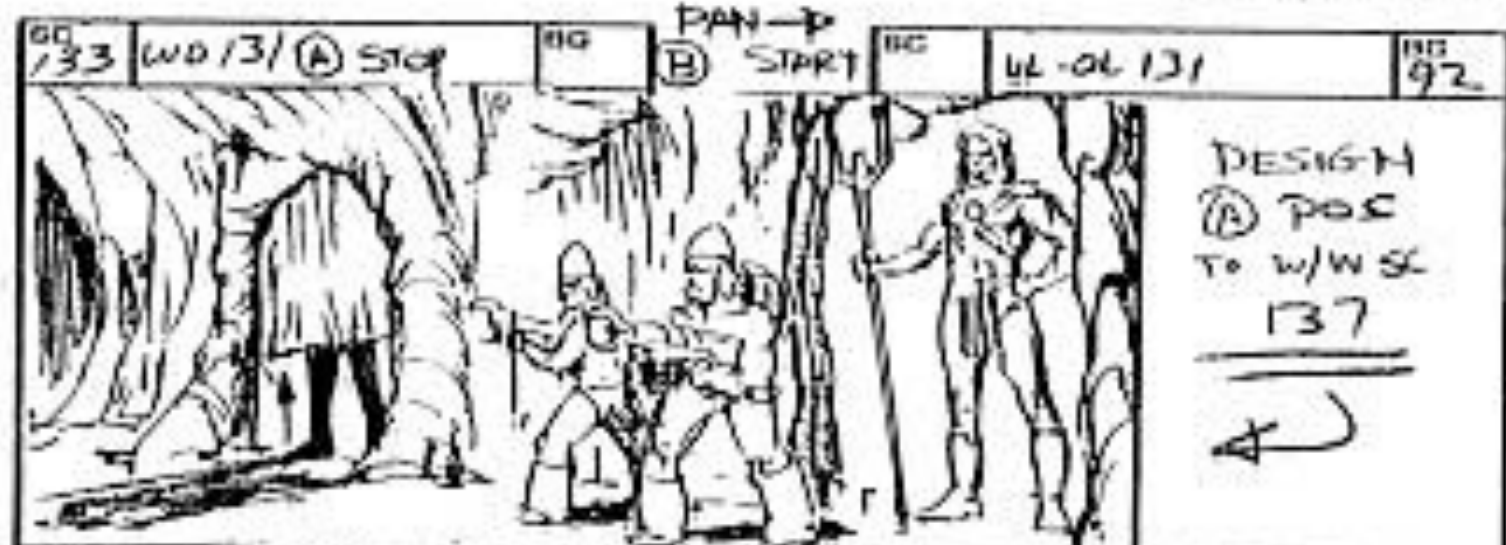

133 WD 131 (A) STOP 110 (B) START 110 UL-OL 131 112  
 PAN FROM SKEL AND TORGs TO ANOTHER CAVE DOOR AS IT OPENS -

SKELETON (VO)  
 A friend of yours is waiting  
 for you!

DESIGN  
 (A) POS  
 TO W/W SC  
 137

L204  
 SC CONT  
 (24)





THE DOOR OPENS FULL TO REVEAL SILH FIGURE OF STRATOS.

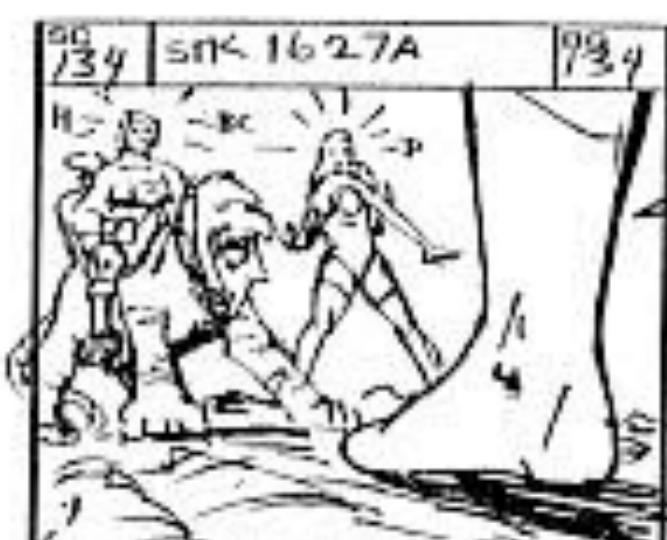

HOLD A BEAM ON THE MAN, BC, AND DELORA. THEY REACT W/ SHOCK AS STRATOS ENTERS SC.



TRK IN ON STRATOS

DELORA (OB)

Stratos

(B) POS

FILMATION  
M-14



SKELETON  
Not just one --

(A) POS

STK 1627A

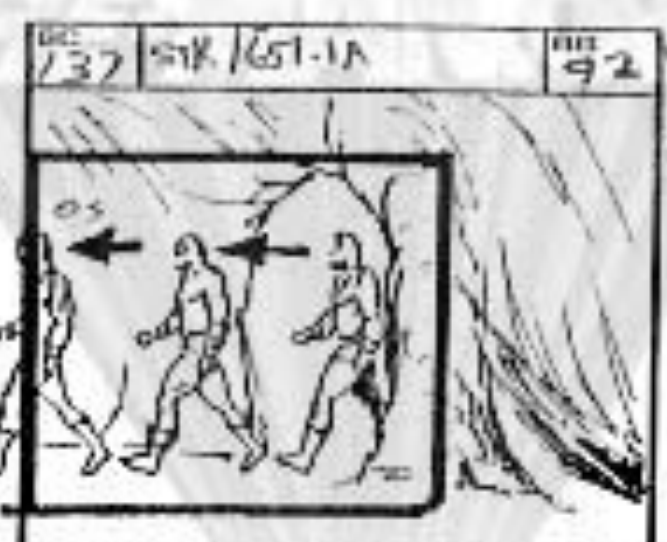

THREE STRATOS WALK OUT FROM CAVE TO OS -  
SKELETON (OB) (cont)

Easy!

(B) POS  
UL-OL 131

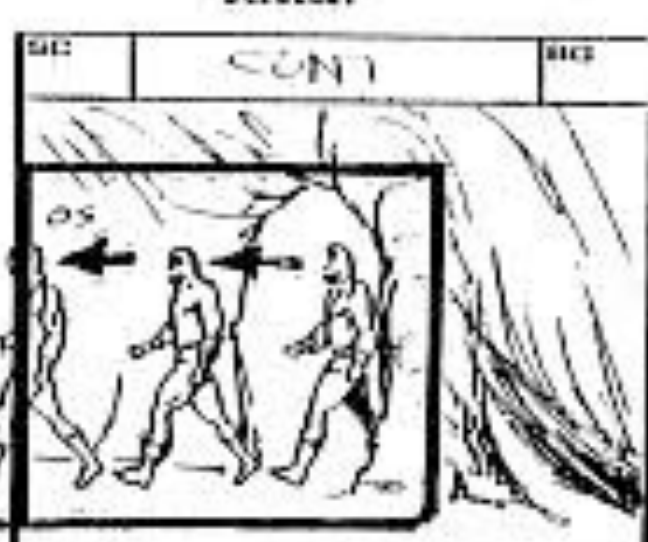

FOLLOWED BY THREE MORE -

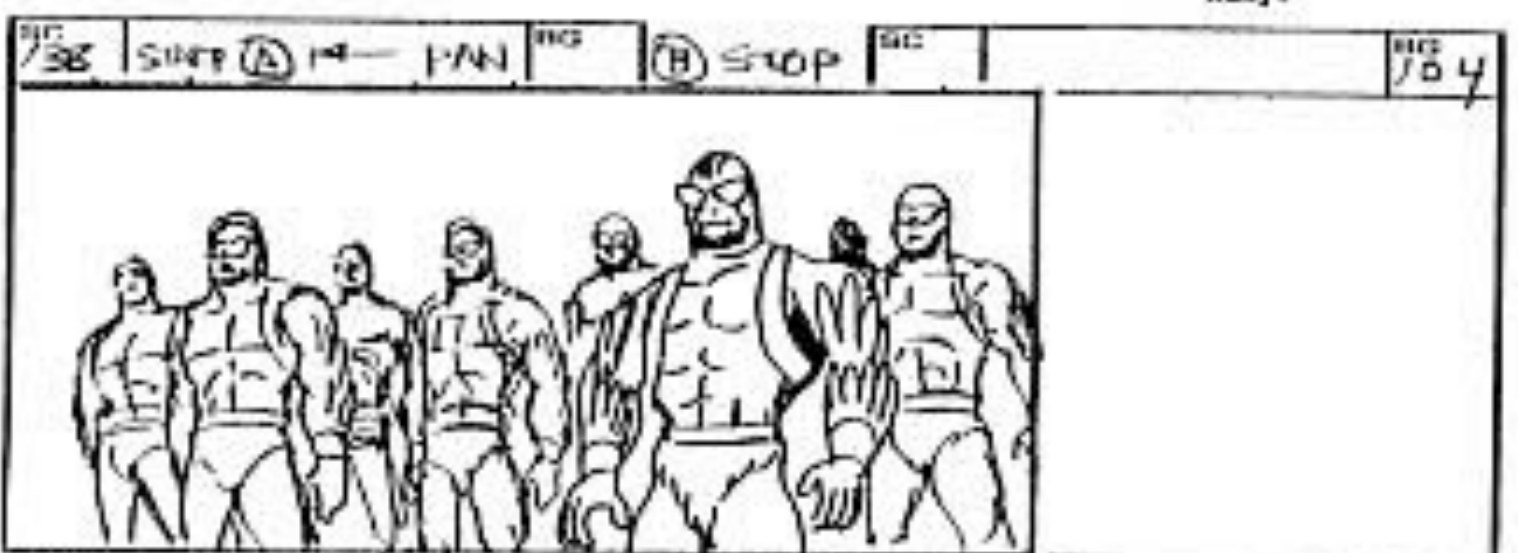

PAN LONG ARMY OF STRATOS CLONES -  
SKELETON (OB) (cont)  
One of them is the real Stratos -  
but all are under my spell!

HOLD A BEAM  
→

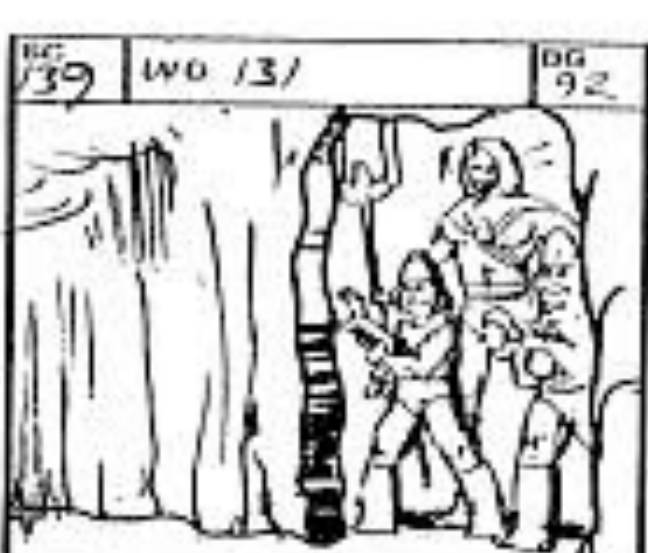

ON SKEL AND TRGS INSIDE CAVE AS -  
SKELETON (CONT) (cont)

(B) POS

UL-OL 131

25

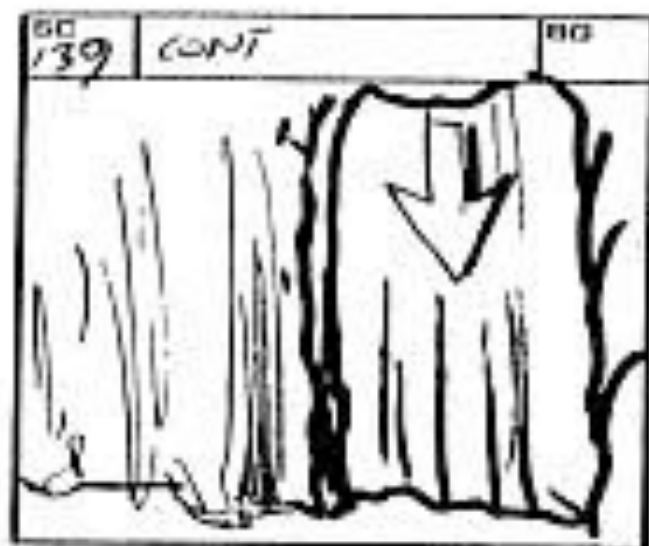

THE DOOR SLIDES DOWN



ON THREE STRATOS CLONES -  
ANTIC...

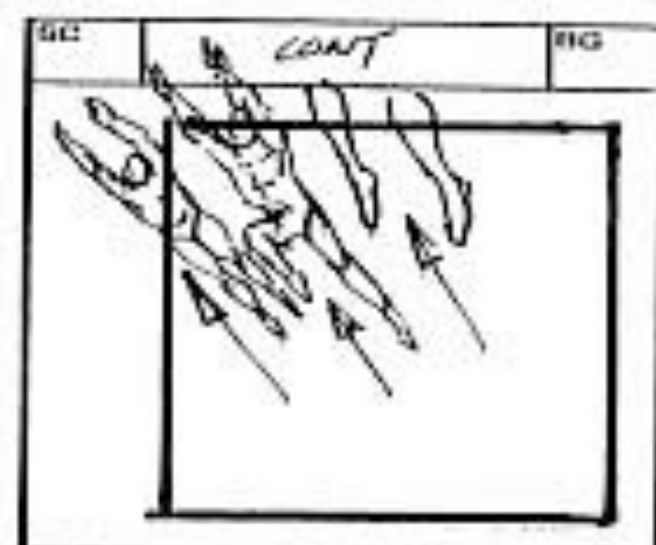

THEY FLY UP AND OUT -



ON GROUND LOOKING UP - READY FOR ACTION.

Don't get too rough until we know which one is the real Stratos!



DAI HOVERING - STRATOS CLONES -  
THREE OF THEM FIRE PALM LASERS -

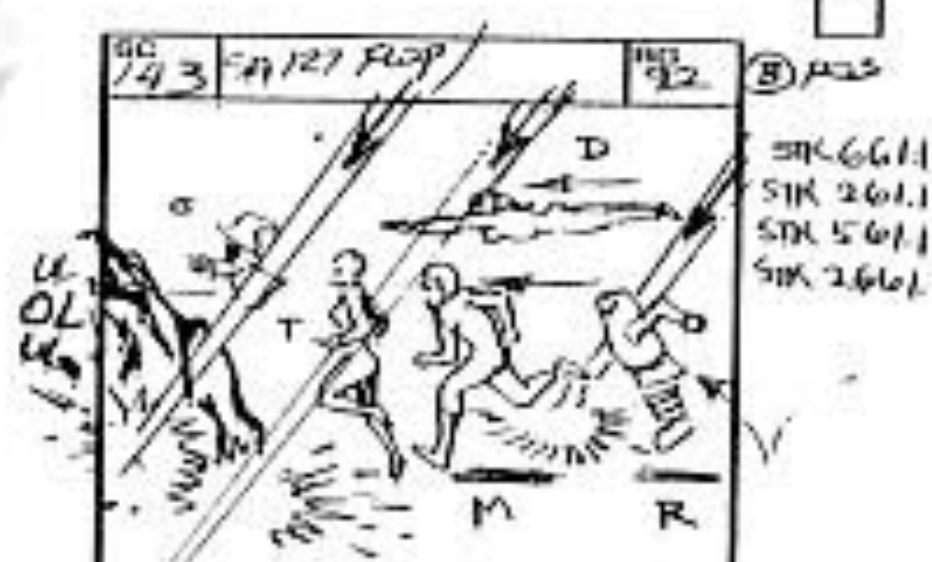

HERO'S FRIENDS RUN THRU SC BEHIND THEM AS LASER RAYS BLAST THRU AREA, MISSING THEM.

SEE ZAP, ZAP, ZAP.

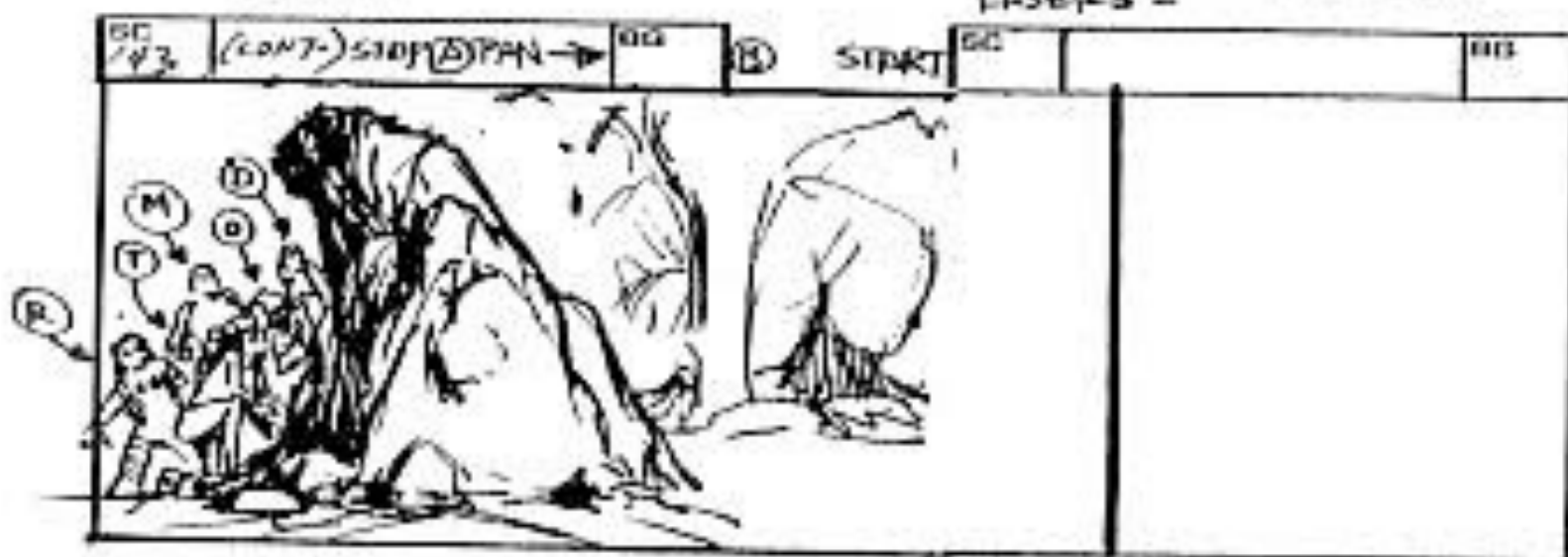

PAN OVER TO SEE MAA, TEELA, MAA, ORSO, AND DELORA COWERING BEHIND ROCK AS...

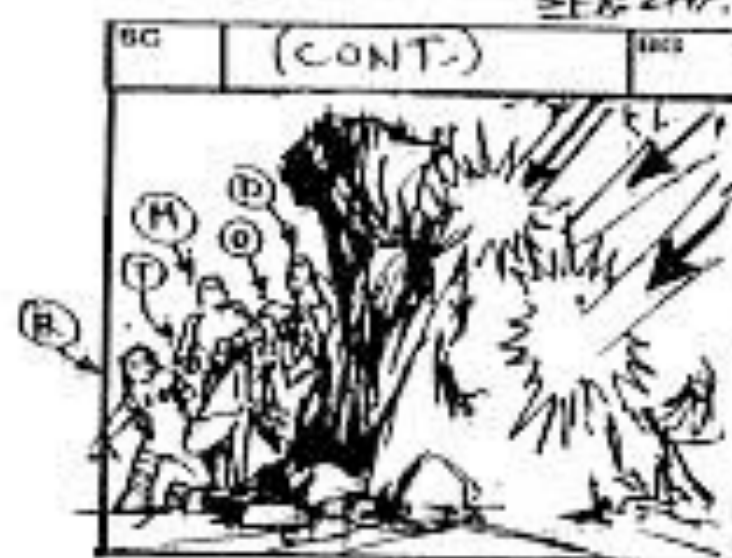

MORE PPS STRIKE ROCK.

M 14

SC 661.1  
SK 261.1  
SK 561.1  
SK 261.1



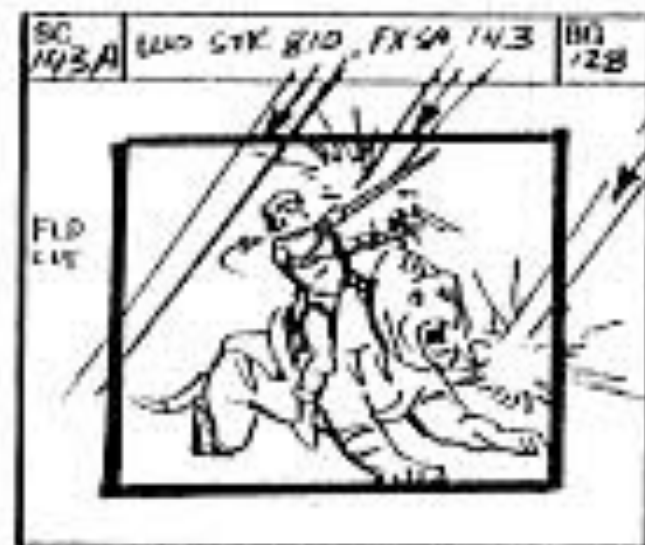

LIKERS FIRE INTO SC - HE MAN BLOCKS A COUPLE OF BOLTS -

(B) PL

HOOK UP



HE MAN THE BOLTS, W/ SWORD - BUT -

(A) PL



A THIRD KNOCKS HIM DC -

001 HE MAN

ILLUMINATION  
143-147



THE STRATOS FIRE PUMP

FLD  
CUT  
&  
TEELA  
HOLDS  
BOLTS



BEING STRIKE ROCK AS HEROES EDNER

(B) PL



STRATOS CLONES SWEEP THRU SC AS ONE OF THEM FIRES A BURST OF LASERS.

RAYS  
SHOOT AS  
FROM HANDS

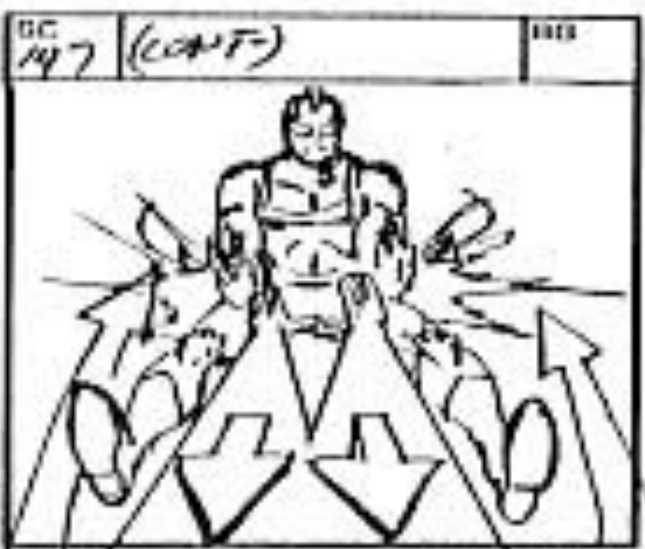

A THIRD STRATOS SWEEP UP INTO SC AND FIRES RAYS TOWARD CAMERA

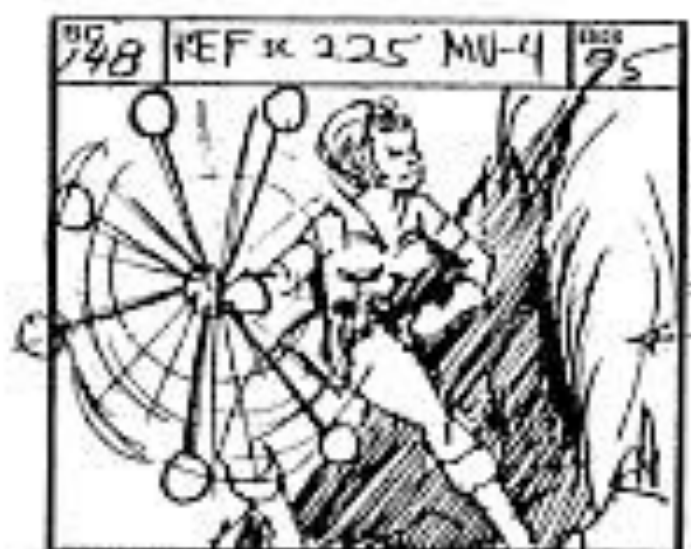

TEELA SPINS BOLTS.

TEELA  
SPINS  
BOLTS



THROWS THEM UP AS - WE SEE DELOPA AND SHAKING ORKO BEHIND ROCK.

27

DROP DIAL: SCRIPT  
 SCS # 152-153  
 NAME NAME  
 YOU guys may be older...  
 NAME NAME (CONT.)  
 But I'm not!

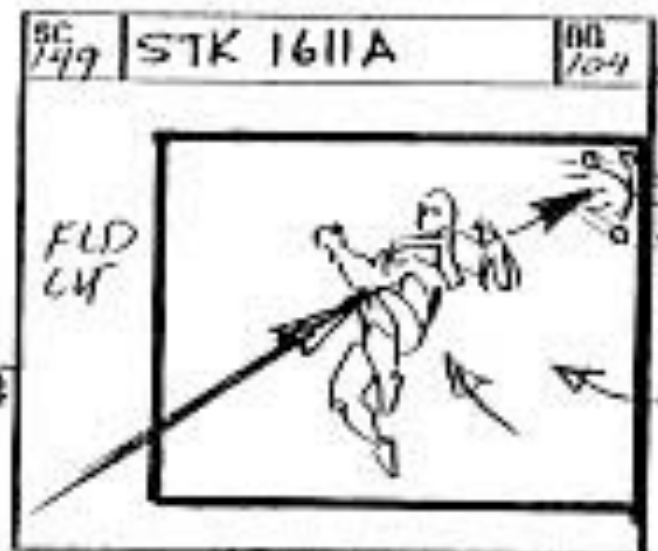

STRATOS CLOPE INTO SC TO STOP  
 AS BOLAS FLY THROUGH HIS  
 BODY AND CONTINUE TO GO

(A)  
 205  
 FADE IN  
 GHOSTLY  
 EPX



TEELA DOES 'BIG' TAKE

(B)  
 205  
 FX  
 143



FRYS BLAST INTO SC AS HIM  
 LIFTS ROCKS -

MIN-16



THROWS THEM AS



STRATOS CLOPE FIRE RAYS -

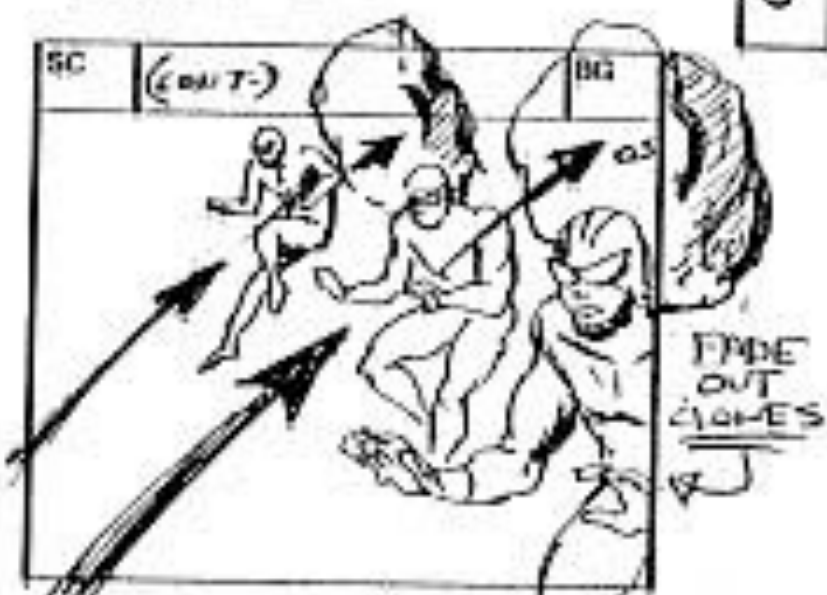

THEY STOP AS ROCKS FLY THROUGH  
 THEIR NOW FRIED BODIES -

FADE  
 OUT  
 CLOPE'S

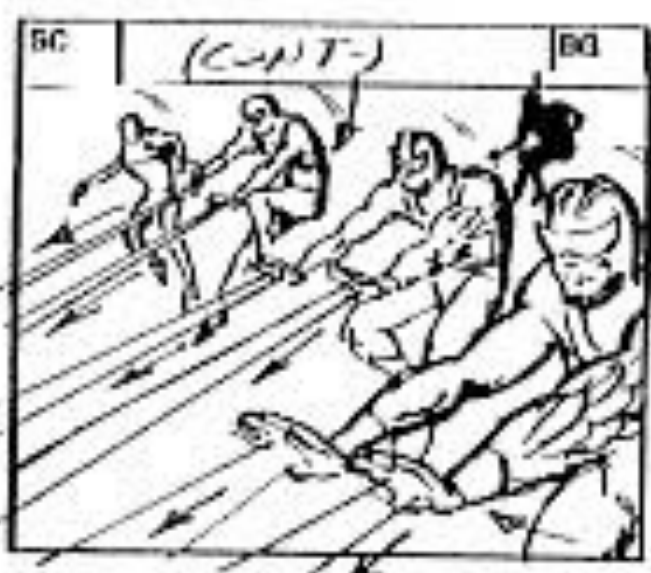

THEY RETURN FIRE BEAMS -

FADE  
 IN  
 CLOPE'S

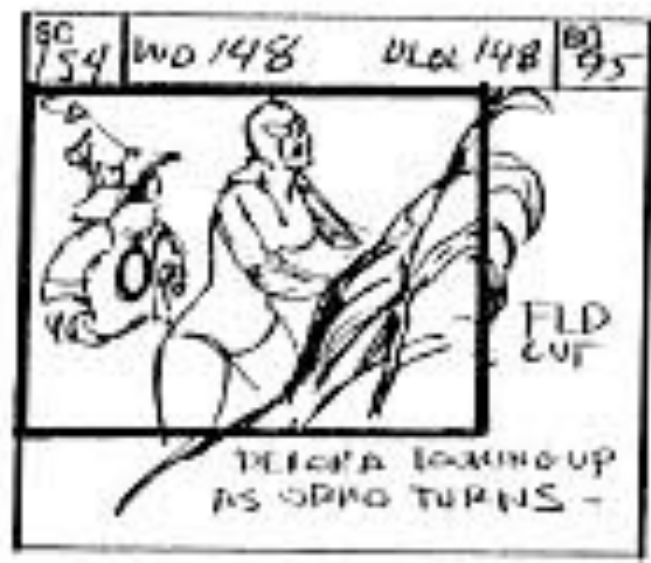

TEELA LOOKING UP  
 AS ORDO TURNS -

TEELA  
 I'll find out which is the real  
 Stratost!

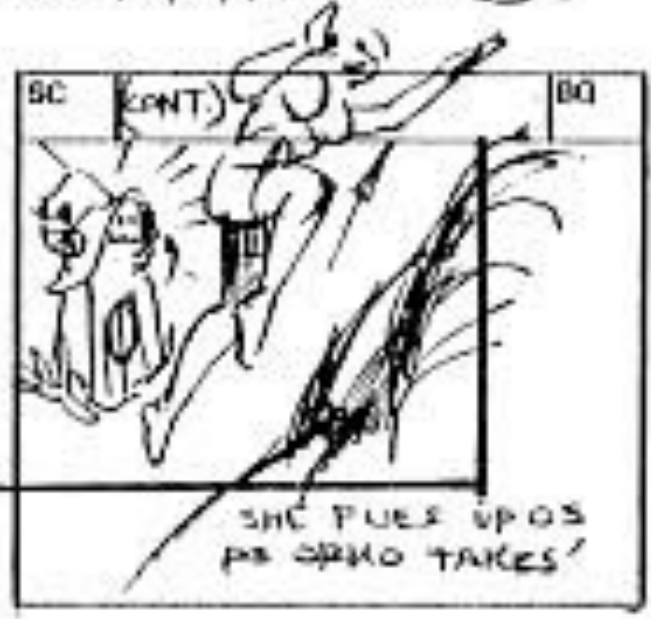

SHE PUES UP OS  
 AS ORDO TAKES'

ORDO  
 Deloral not



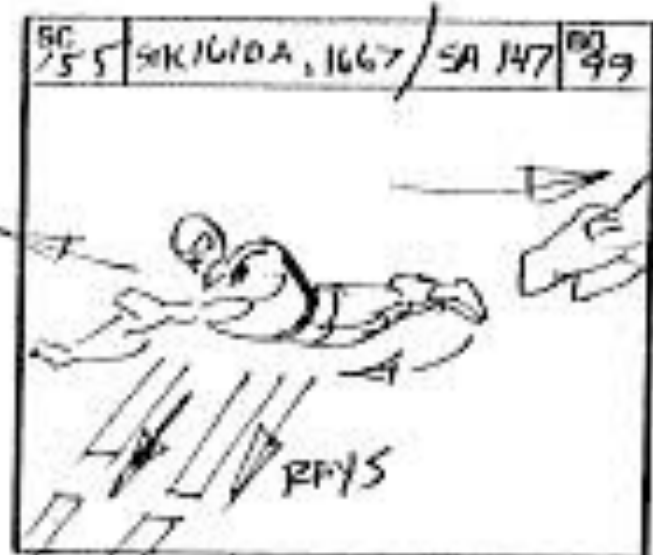

STRATOS CLONES SWEEP THRU SC



ANOTHER STRATOS THRU SC -



TWO MORE STRATOS THRU SC

161-16

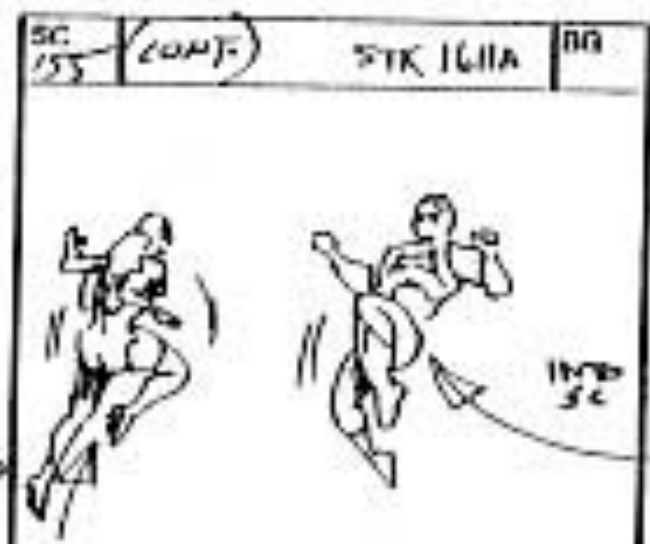

INTO SC

DELORA HOVERS INTO SC AS THE REAL STRATOS ENTER-HOVERS-

DELORA (16)  
STRATOS (1)



DELORA HOVERS

DELORA (CON'T)  
We are not your enemies!

TRK IN ON HOVERING STRATOS



DELORA (CON'T) (VO)  
Fight the evil spell that's been placed on you!

(C) POS.  
SEE SC 162 FOR FULL SETL



STRATOS REACTS - THROWS HANDS OVER HEAD AND STRAINS-

HOOK UP



STRATOS TRIES TO FIGHT THE SPELL AS OTHER CLONES ENTER TO FIRE BEAMS-

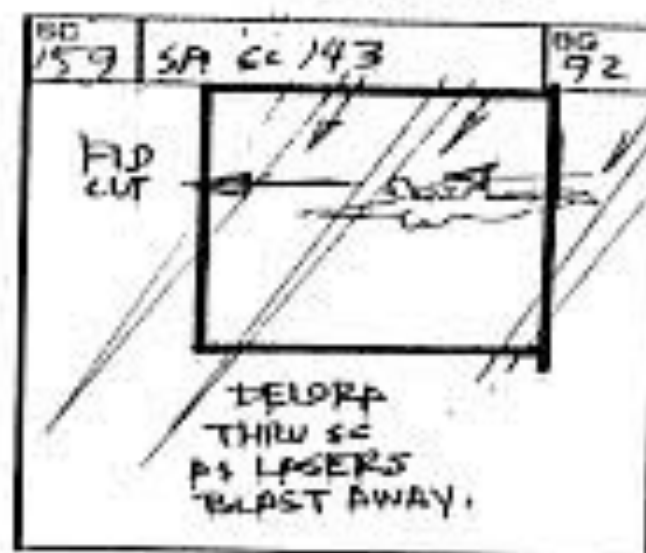

DELORA THRU SC AS LASERS BLAST AWAY.

(B) POS

29



TRK IN ON STRAINING STRATOS

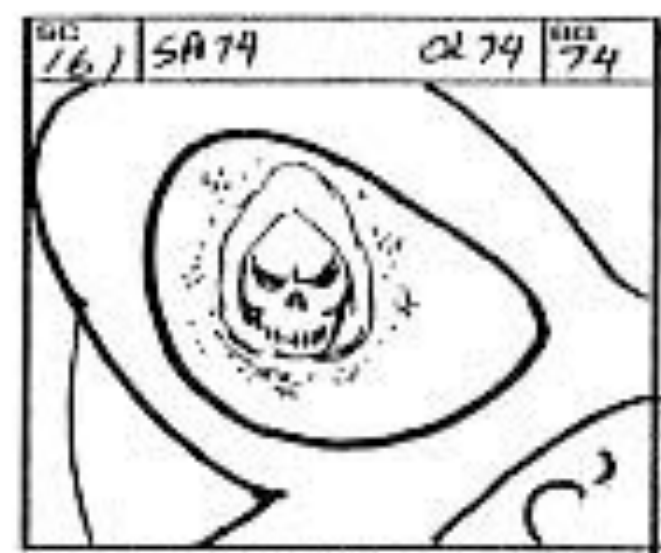

CLOSE ON HIS EYE AS  
IMPGE OF SKELETON FADES  
OUT - -

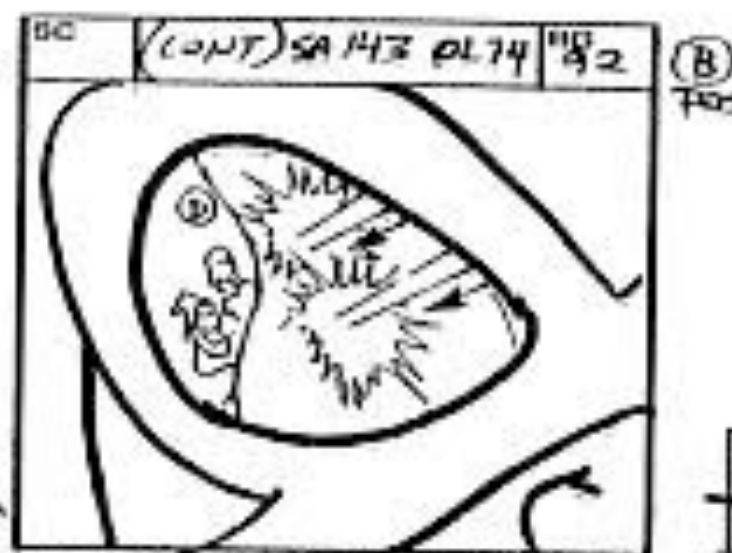

FADÉ IN IMAGE OF DELORA AND  
ORIN BEHIND ROCK AS RAYS FIRE  
STRATOS (W)  
INTO SC - (coming out of spell)  
Delora?

PUMATION  
 11-11-12



HE SNAPS OUT OF IT - REMTS TO  
THE PERIL TO HIS SISTER -

STRATOS (CON'CI) BOI



HE LOOKS OS - PAN TO TWO CLONES AS THEY START TO FIRE  
THEIR PALM LASERS - - BUT BEFORE THEY DO - -

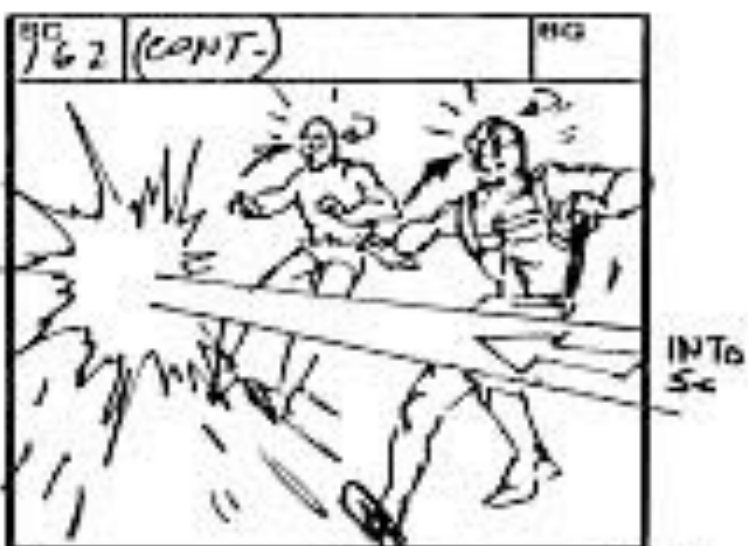

STRATOS FROM OS FIRES A LASER  
BY FIRE IN FRONT OF THEM -



OR MAN  
That's the real Stratos!

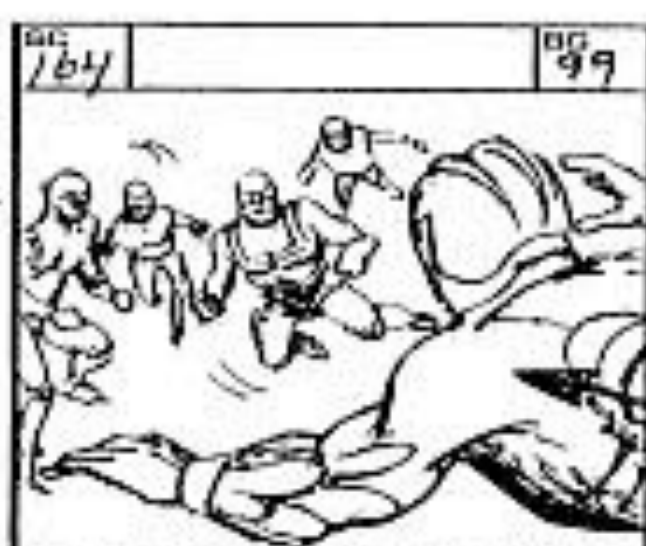

STRATOS HOVERS INTO SC TO CONFRONT THE  
OTHER CLONES - STRATOS (CON'CI) (VO)  
My will has returned, and yours  
is gone!

REF  
STRATOS  
TO  
HOVER

30



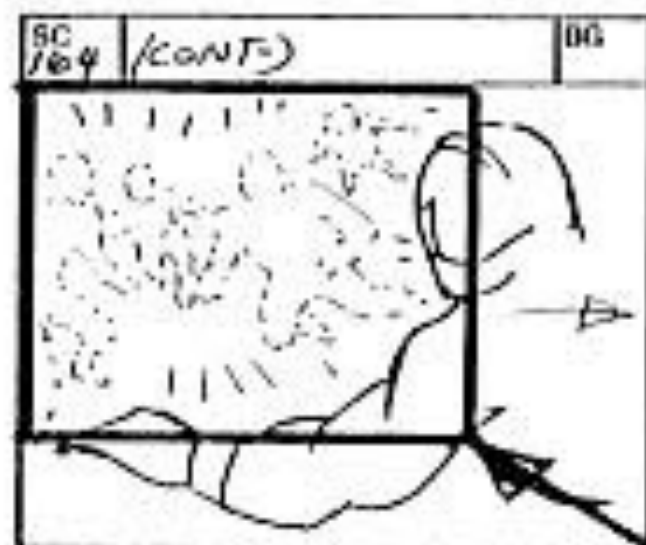

TRIL IN AS THE CLONES FADE OUT -



SUGGEST DIAL:

TRILLA: "THEY DISAPPEARED!"  
MPH AT ARMS: "THEY MUST HAVE BEEN ILLUSIONS CREATED BY SKELETOR!"



HAPPY DELORA AND DREX LOOKING UP AT OS STRATOS FROM BEHIND ROCK.

DELORA  
You're free of Skeletor's magic now!

UL-OL  
148

MIN-16



INT-TOROS CAVE = SKELETOR GESTURES AT CRYSTAL CAGE OF MALKROM AS TOROS IN SILD WATCH



(C) POS  
SKELETOR HOLDS STAFF OF AVION

SKELETOR (Vo)  
Staff of Avion... I command you --

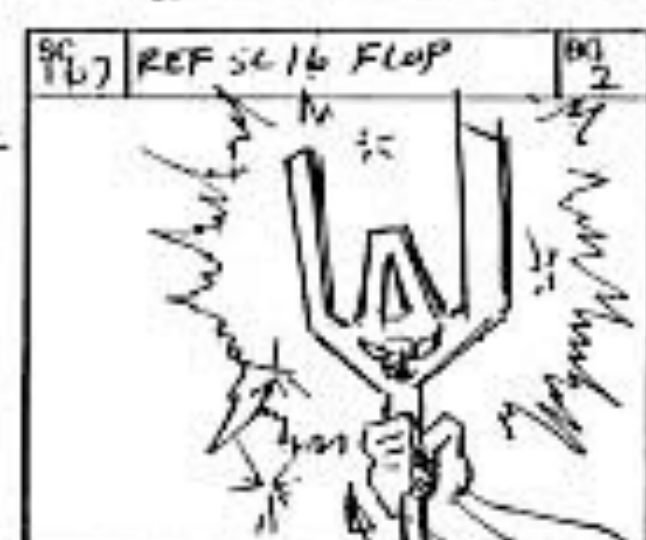

(A) POS  
SKELETOR LIFTS THE STAFF IN SC - FX FADIN ON AS IT STARTS GLOW.

SKELETOR (con't)  
Show me the weak point!

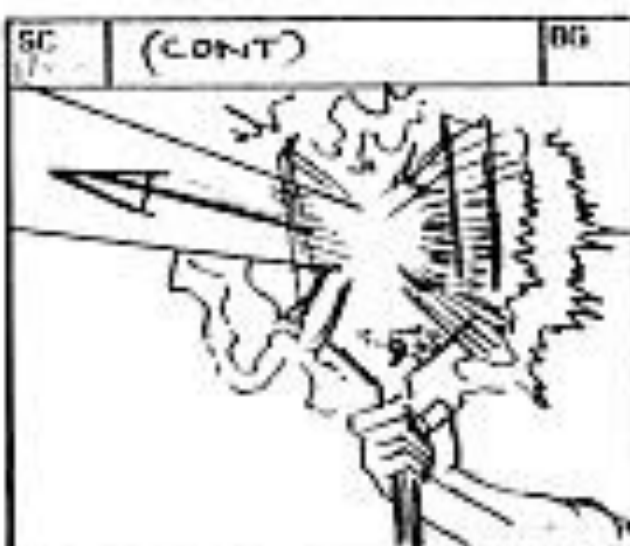

IT BUILDS POWER AS IT FIRES A CONTINUOUS BEAM O3



CLOSE ON MALKROM ENCASED IN SPARKLING CRYSTAL CAGE AS--

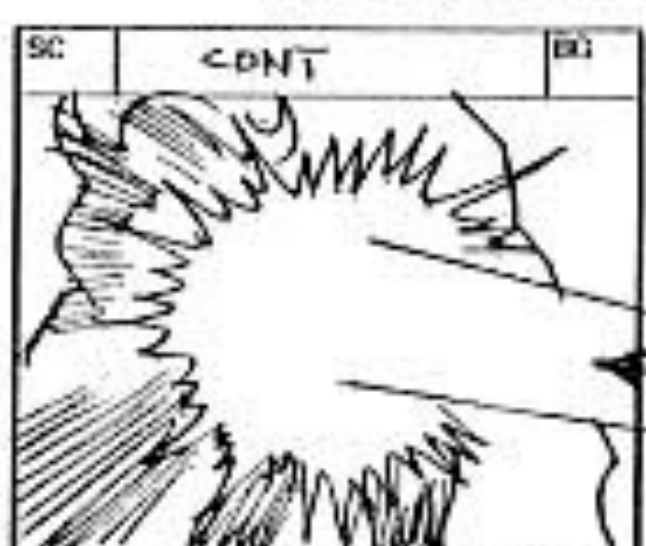

THE STAFF'S LIGHT BEAM ENTERS SC -

FADE IN DX FX

SC CONT

3/

TRICK IN AS A SMALL CRACK APPEARS INTO VIEW - MAINTRIN GROWING FX A BEAT

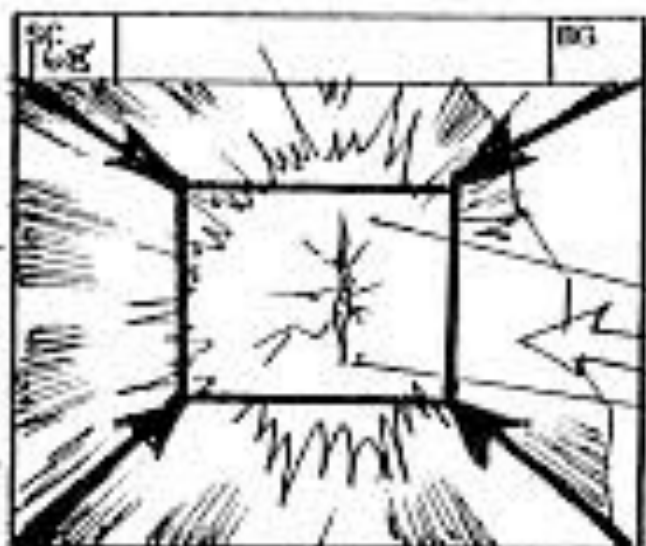

SC 168  
SKELETON (CG)  
There it is!

FADE OUT BEAM

UL 169  
CRISTAL



SC 169 SYK 301, SA 132  
SHEL TURNS TO FIRM AS HE REACTS TO...

1 TORO GUARDS (CG) 2 SKELETON (SBOOTS) What?

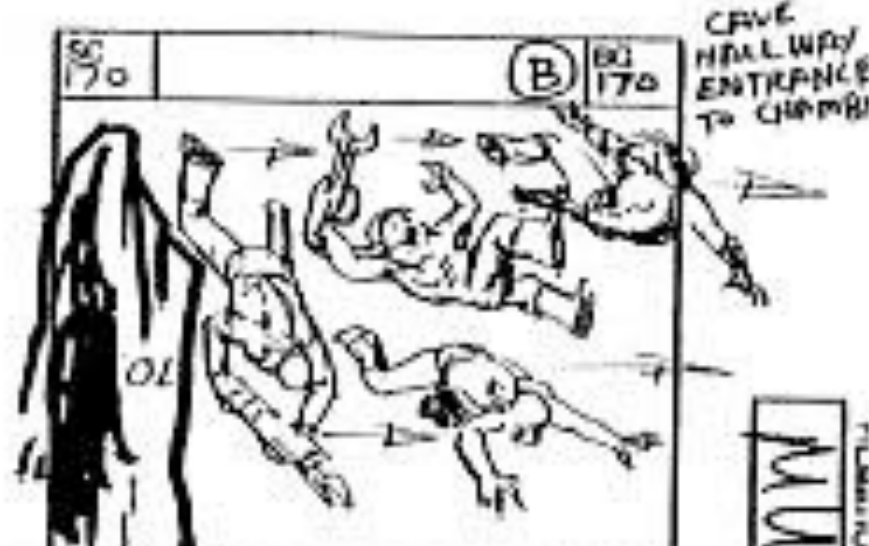

SC 170 (B) SC 170  
TORO GUARDS THROWN THRU SC

CAVE HALLWAY ENTRANCE TO CHAMBER

91 - MM  
GENERAL'S QUARTERS



SC 170 (CONT) SIDE (A) PAN -> (B) START SC  
PAN (B) TO (A) AS WE SEE HIM, SC, DRUG, DELORA, STARTUS, TEELA, MAA, AND RAMPAGE IN ONE BEAT - BE MAN  
We have some unfinished business, skeleton!

PAN ON A FASTER SPEED TO REVEAL BATTLE (PT)



SC 171 SA 131  
TORO SOLDIERS ARE DAZED AND STUNNED BUT NOT HURT  
LONG ON SKELETON. HIS SOLDIER ARE FLEED PROUD HIM.  
SKELETON  
Toro, He had!

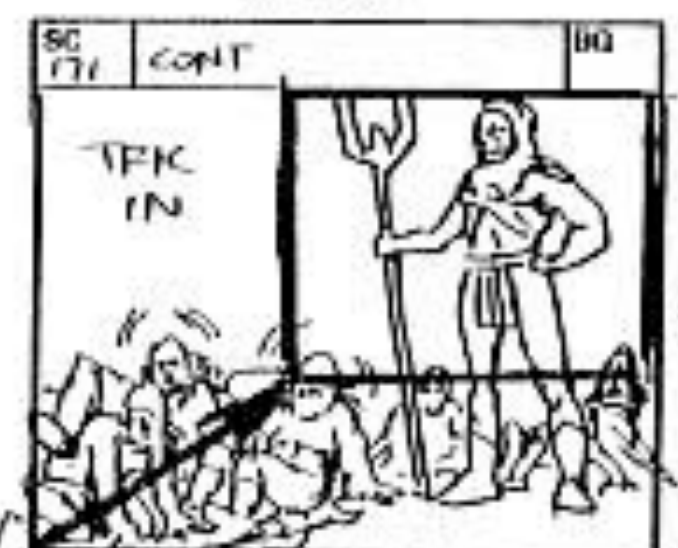

SC 171 CONT  
SKELETON (CON'T)  
and now is the time to finish it!

EYPOSE BRIGHT SUNBURST CARD 30% ON 2ND PASS FOR RAY FX



SC 172 SA 167  
SHEL RAISES STAFF, FIRES LIGHT BEAM

HOLD ON TO THE STAFF

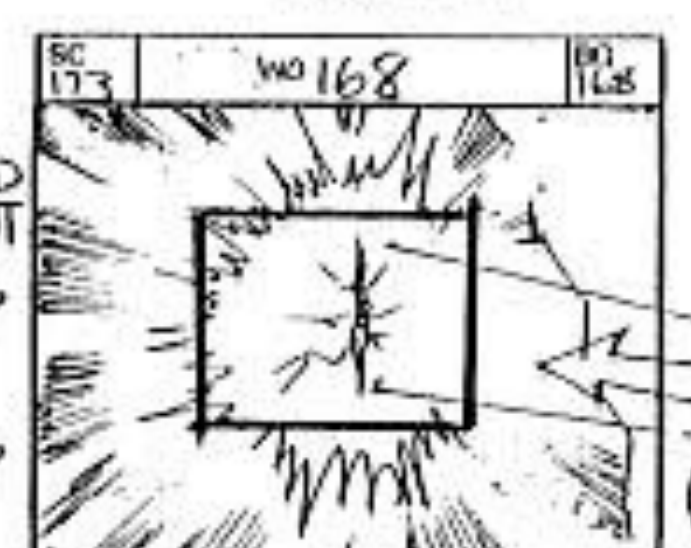

SC 173 WO 168  
LIGHT BEAM STRIKES CRISTAL - CRACK DISSOLVES ON...

32



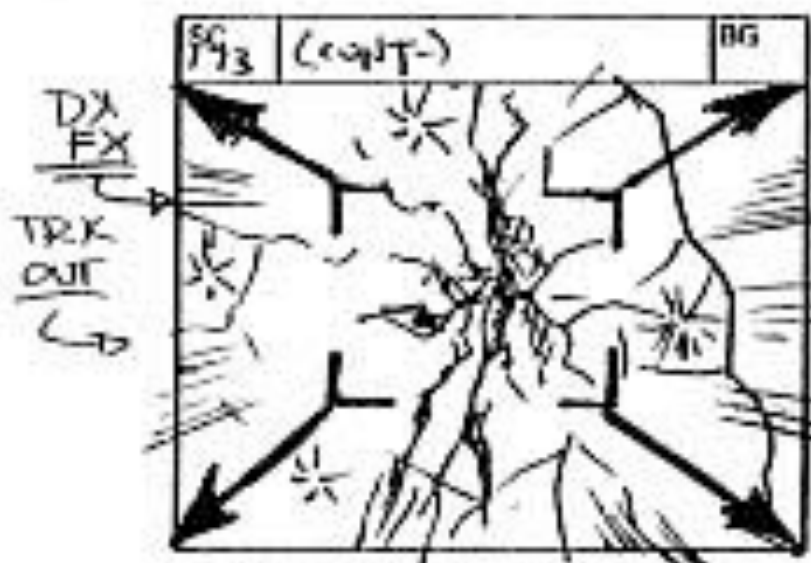

THE CRACK GROWS AS THE LIGHT BEAM FADES OFF...  
SFX: RUMBLE



THE CRYSTAL EXPLODES OPEN -  
PIECES FLY OFF - SFX: EXPLOSION!



HE MAN REACTS TO BLINDING LIGHT FX.

91-91  
 STORY BY JAMES HAMILTON  
 ART BY JAMES HAMILTON



TRK IN AS HE LOOKS UP AND DOES A TAKE  
 SKELETON (OB) (CON'T)  
 Foolish mortals --

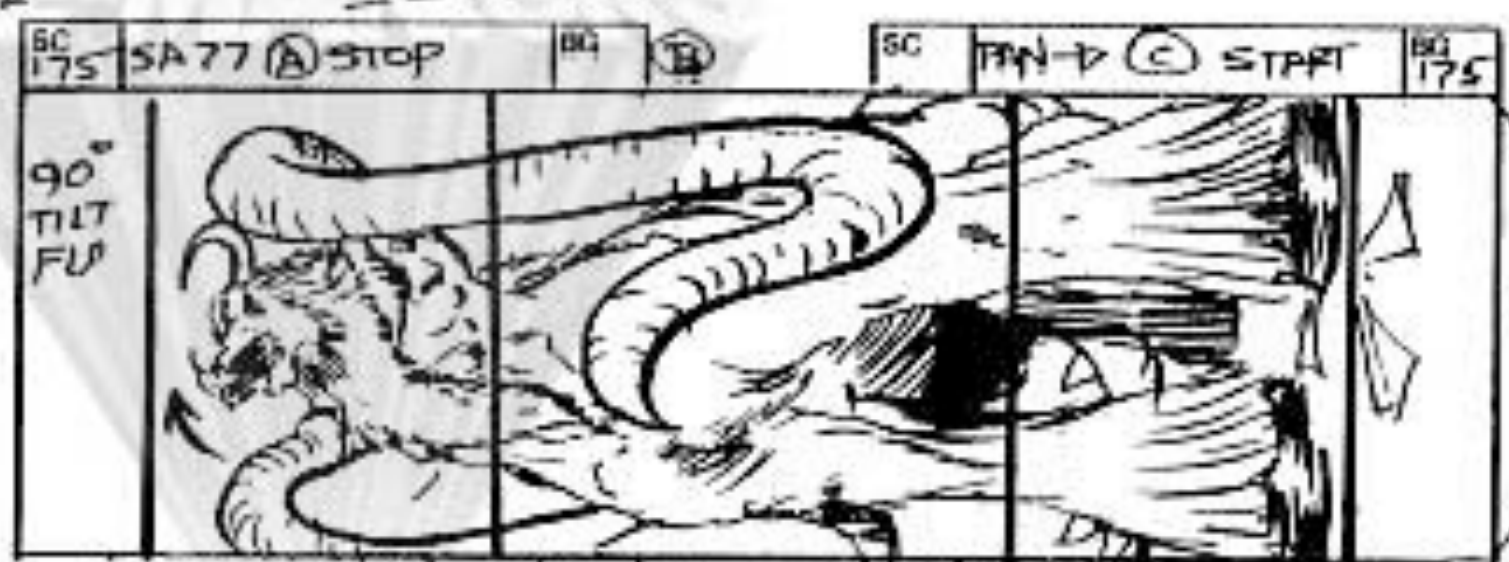

PAN UP EXTREME UPSHOT OF MOLTROM AS HE REARS HEAD.  
 (1) SKELETON (OB) (CON'T)  
 Say hello to Moltrom!  
 (2) MOLTROM (BELLOW)

SC [ ] [ ] BG [ ]

END OF ACT ONE  
 MU #66016

SC [ ] [ ] BG [ ]

/

SC [ ] [ ] BG [ ]

/



# HE-MAN AND THE MASTERS OF THE UNIVERSE

"REIGN OF THE MONSTER"

NU #66016

JANUARY 26, 1983

ACT TWO

STORYBOARD BY DON MANUEL

91-111

YEROX DOWN S/A SC 170 GROUP

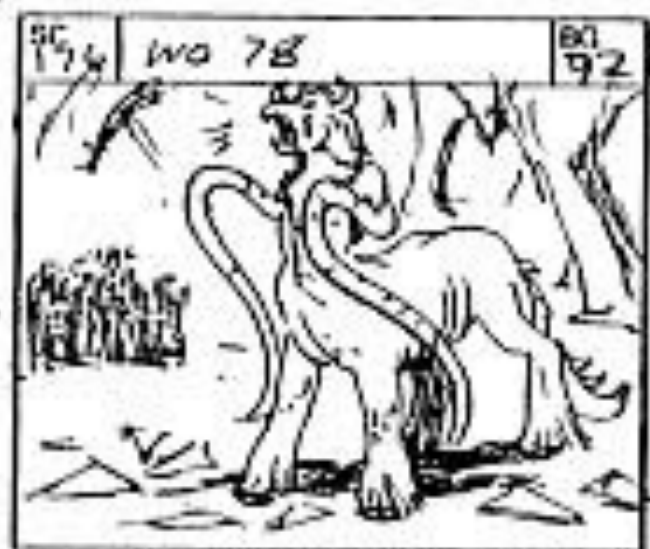

176 WO 78 BK 92  
MOLOKROM (bellow)

HOOK UP



177 SK 157  
MOLOKROM TURNS LOOKS AT SKELETON (COS)

HOOK UP  
SHEL HOLDS STAFF OF AVION



178 STK 357A BK 178  
DOWNSHOT ON MOLOKROM & SKELETON (COS)  
1. Skeleton, have freed you

YON



179 S/A 170 BK 179  
ON HEROES - SKELETON (COS cont) now vanquish by enemies!

HOOK UP



180 WD 177 BK 157  
MOLOKROM TURNS, REARS BACK TO INHALE ---

HOOK UP



(CONT-) BK  
HE EXHALES A MIGHTY WIND.

34



LAYOUT  
NOTE:  
ORKO  
SHOULD  
HOLD HIS  
HIPS DOWN  
W/ BOTH  
HANDS

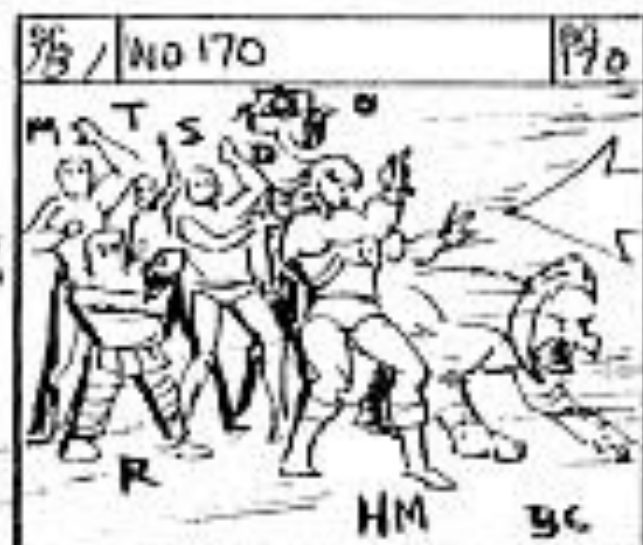

THE HEROES REACT AS WIND  
BLOWS INTO SC.

SFX: WIND STORMING

(A) POS

STK  
WIND  
FX 9

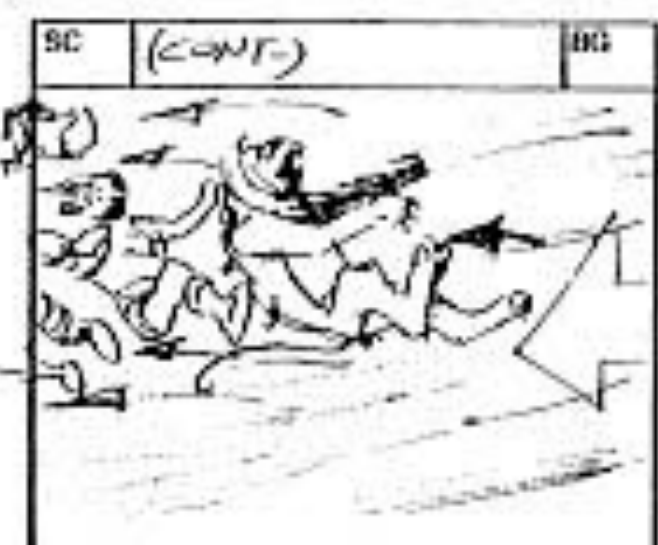

THE POWERFUL STORM CARRIES  
GROUP AS -

ORKO



ON CAVE AS TEELA, M'A'A,  
ORKO, STRATOS, AND DELORA  
ARE BLOWN INTO IT---

VL  
02  
182

91-112  
FILMATION STUDIOS



FOLLOWED BY RATHMAN, BC,  
AND HEYMAN -



ON MORKROM BLOWING -

(B) POS



HE REARS, BREAKS INTO EVIL  
LAUGH -

MORLORON  
(evil laugh-growl)



HE BREAKS GRIN AND FIRES  
MAGIC RAY BEAMS FROM  
EYES.

TRX

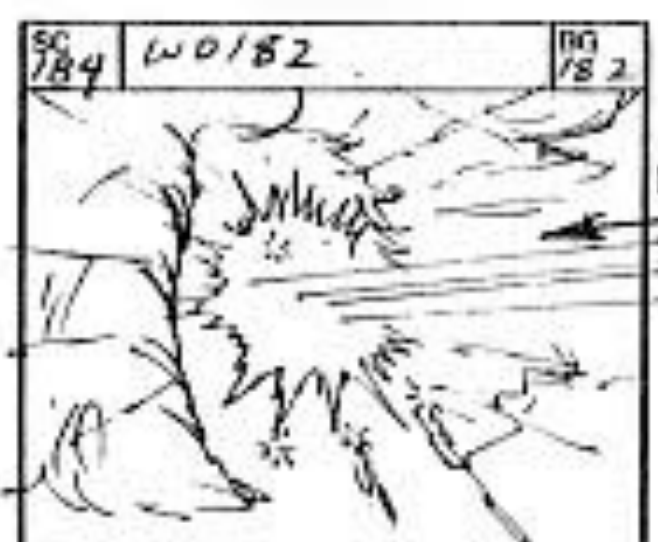

PLAYS FIRE INTO CAVE ENTRANCE  
(NOT THRU IT) AND MAGIC FX  
FADES IN AND OUT -

RPYS  
IN

FADE  
IN  
SEAL



ROCKY SEAL FROES IN,  
TRAPPING OUR HEROES INSIDE CAVE.

SPELETOR 1001  
That takes care of them!

PLAYS  
DISSOLVE  
OFF

35



FLD CUT  
 UPSHOT - MOLKROM LOOKS DOWN AT SKEL  
 SKELETON (CON'T) (VO)  
 Now Molkrom and I will take care of Graykull!

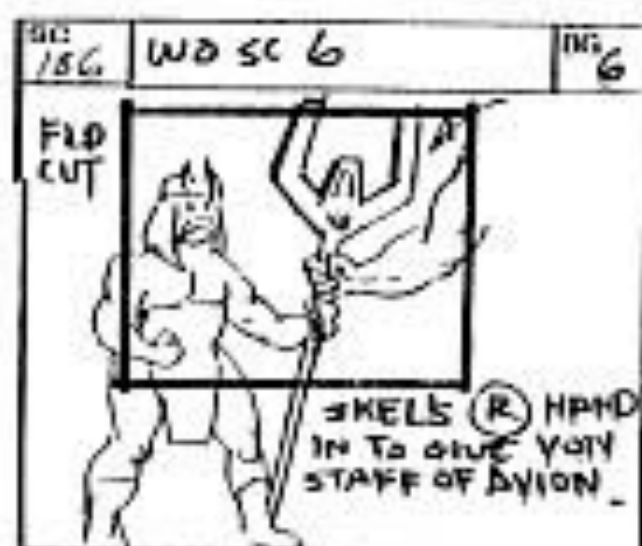

FLD CUT  
 SKELETON (R) HAND IN TO GIVE YOU STAFF OF DYION.  
 SKELETON  
 Guard this staff well, You.



FLD CUT  
 TRK OUT FROM SEALED CAVE OPENING. SEVERAL PAVED HERATS AS HM AND BC LISTEN TO... SKELETON (CON'T)  
 When I get back, I plan to learn more of its secrets!

FILMATION  
 111-16



FLD CUT  
 SKEL, SITTING ON MOLKROM, POINTS TO OS -  
 SKELETON (CON'T)  
 Molkrom

NOTE:  
 SKEL HOLDS HIS OWN RHM STAFF



TRK IN AS MOLKROM LOOKS OS.



ON WALL -

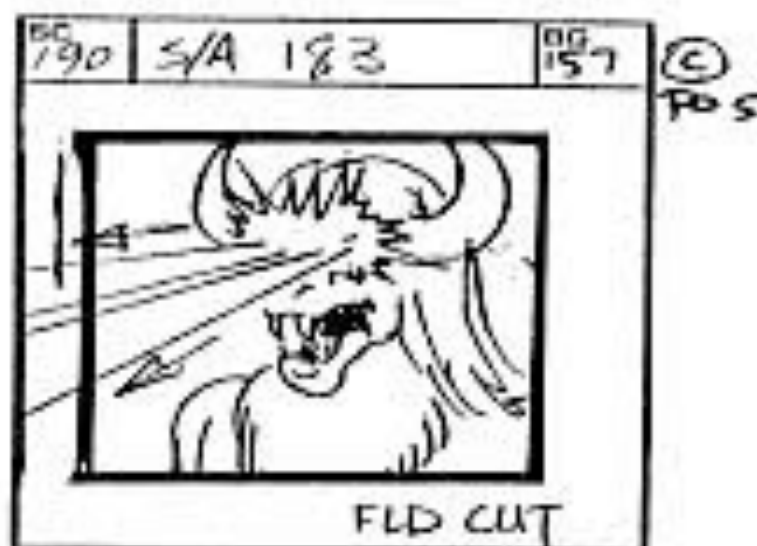

FLD CUT  
 MOLKROM FIRES RAYS



FLD CUT  
 RAYS STRIKE WALL.



WALL PORTION DISSOLVES, EXPOSING OUTSIDE NIGHT PLAINS -

36



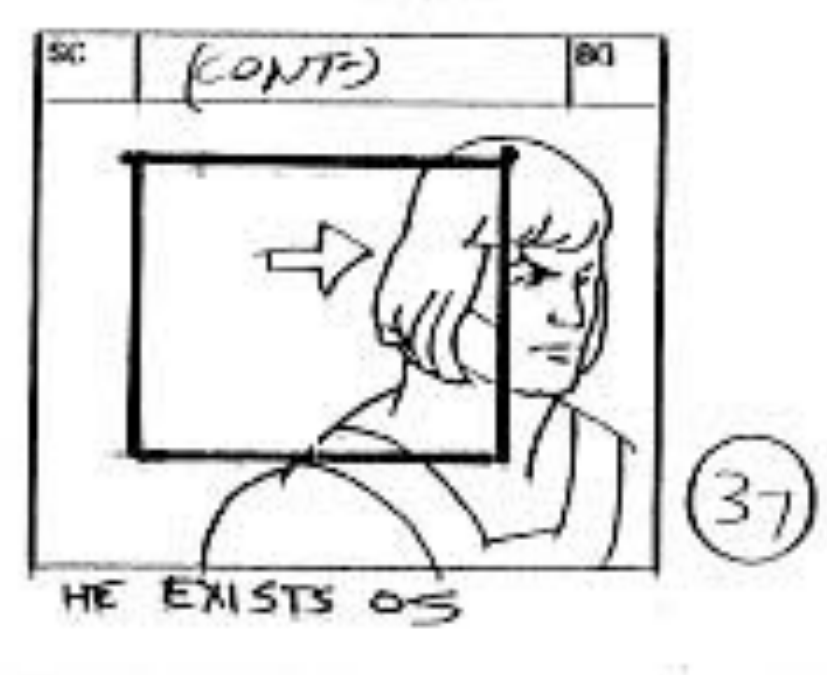
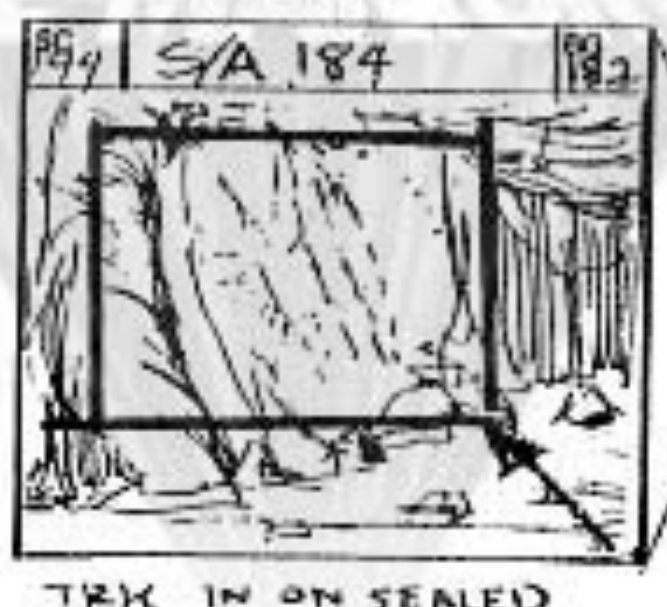



HE MAN STRAINS TO SLOWLY MOVE RACK



CLOSER AS HE MAN STRAINS AS ROLL BARELY MOVES.

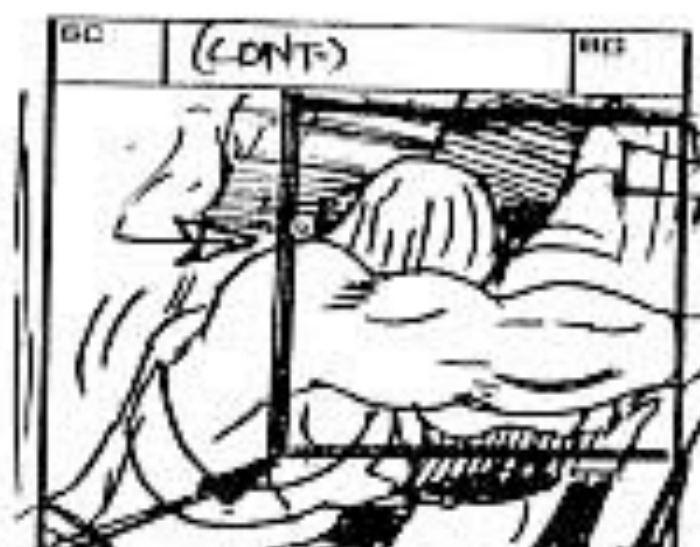

HM CONTINUES TO PUSH IT UNTIL HE STOPS

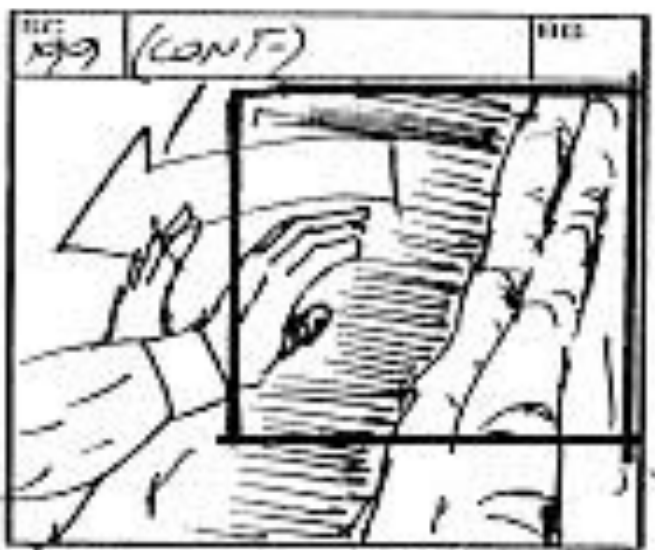

HM STEPS BACK AS -



HM DIALS - AN TIC -  
HE MAN (COS'G)  
Maybe there's a quicker way!



THROWS FIST TO CAM.



CRACK OPENS W/ OS HM'S PUNCH  
SFX: BAM!



ROLLS EXPLODE TO OS FROM HM'S SECOND PUNCH...

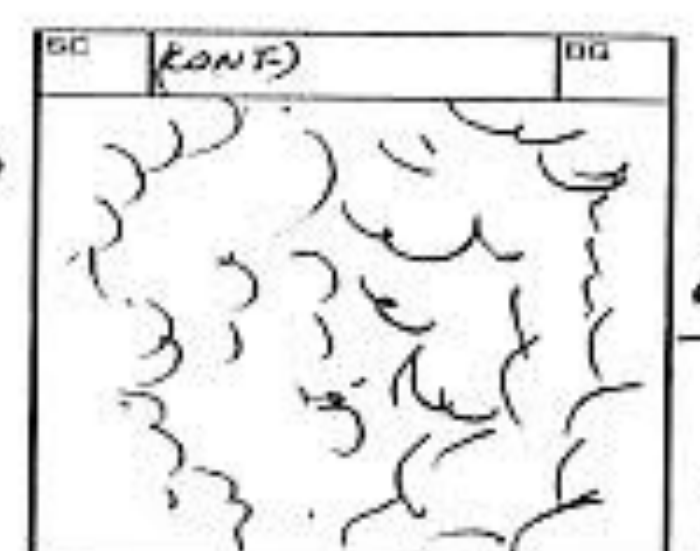

SMOKE AND STK DUST FILL SC.

X  
01187X  
Hook up

X  
SLIGHT CAM SHAKE

TO LEFT SHAKE

ANIMATION  
MIA-16

CAM JOLT

BIG CAM SHAKE

FN SFX 201

SC CONT

30





DUST CLEARS, REVEAL HEMAN STANDING IN OPEN WALL.



BATTLE CAT INTO SC -  
SFX: GROWL!!



HIM MOUNTS BE -

27  
28  
FILMATION  
91-111



FACES CAM.



HE MAN (VO)  
Hem Man and Man At Arms --  
I'll need your help at Grayskull!



Be Man (VO)  
The rest of you -- get that  
stuff... ..before it explodes!



LATER, THAT EVENING - - -



TRK IN ON TOWER OF GRAYSKULL

HOLD ON 1081

(CONT)

6X  
UL-OL 207X  
EYEPAGE  
WHITE  
CARD  
30%  
ON 2ND  
PASS FOR  
LIGHTING  
FX



TRK IN ON TOWER WINDOW AS  
SORCESS FADES INTO ST,  
WINGS SPREAD.

UL-OL  
150X  
MV-9



SORCESS PINGS IN, ARMS  
LOWER AS SHE LOOKS OUT

FILMATION  
M-10

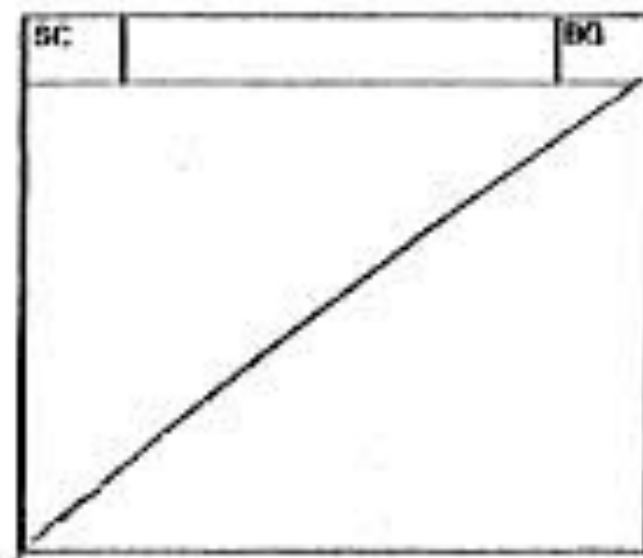

WINDOW  
UL  
209X

TRK  
IN

SKEL  
HOLDS  
THE  
RAM  
STEP



POV - SORCESS SEES SKEL AND  
MO

OL 209X  
WINDOW

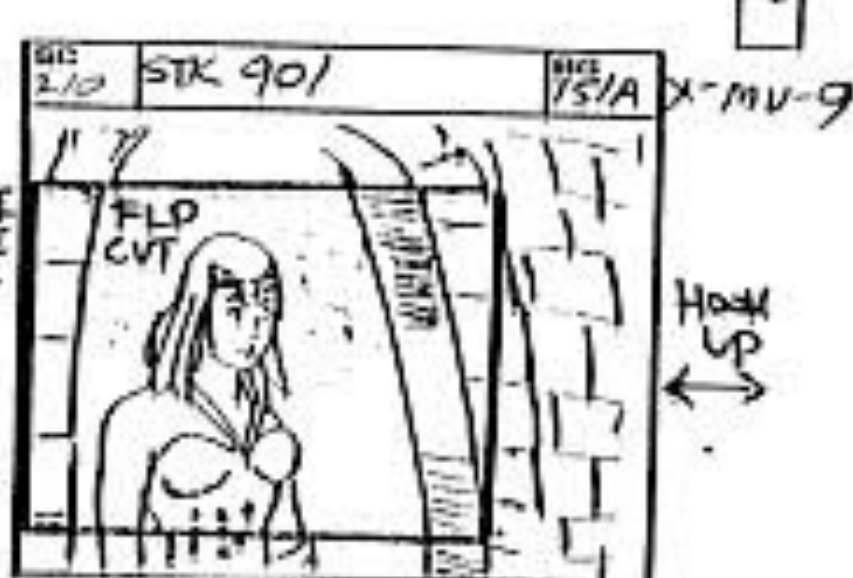

LOOKING DOWN -

SORCESS  
It's Molkrom!

SORCESS (cont)  
Maybe this will stop him.

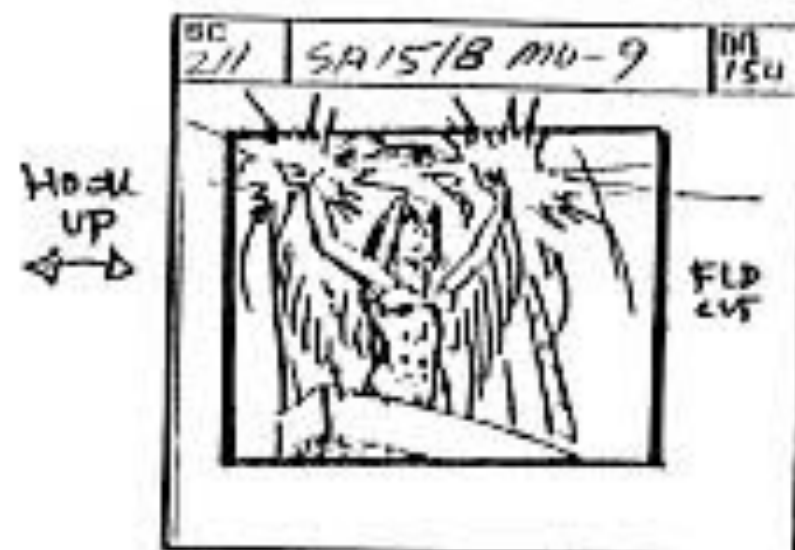

SHE RAISES ARMS, FX FADE  
ON FROM HANDS -

UL-OL  
150X  
MV-9



LONG ON MOLKROM AT EDGE  
OF RAMP AS...

STK  
FLAMES  
FX 3

OL  
212X



FLAMES RISE FROM THE GORGE  
MOLT - MOLKROM REACTS

40



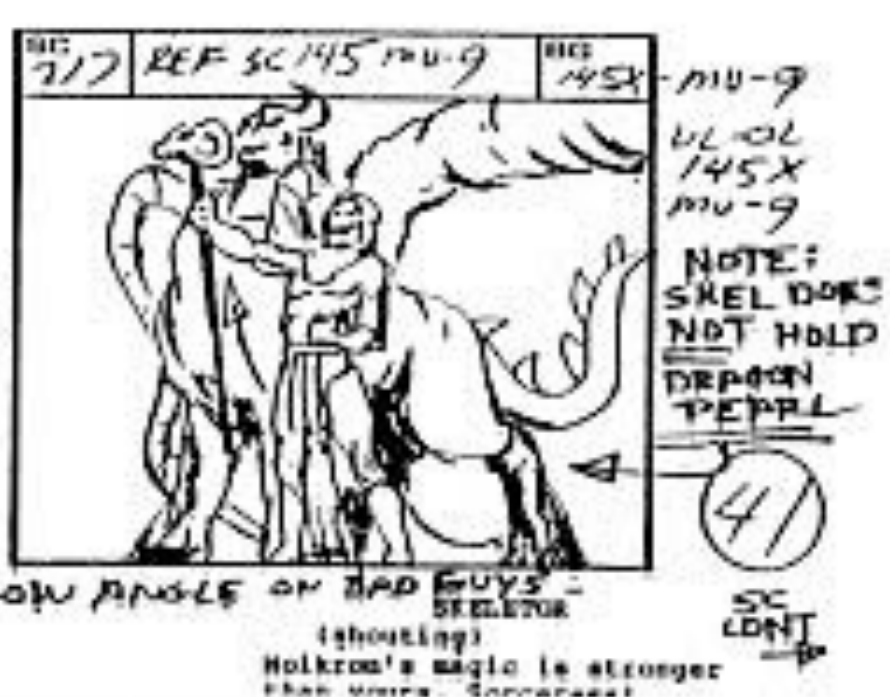
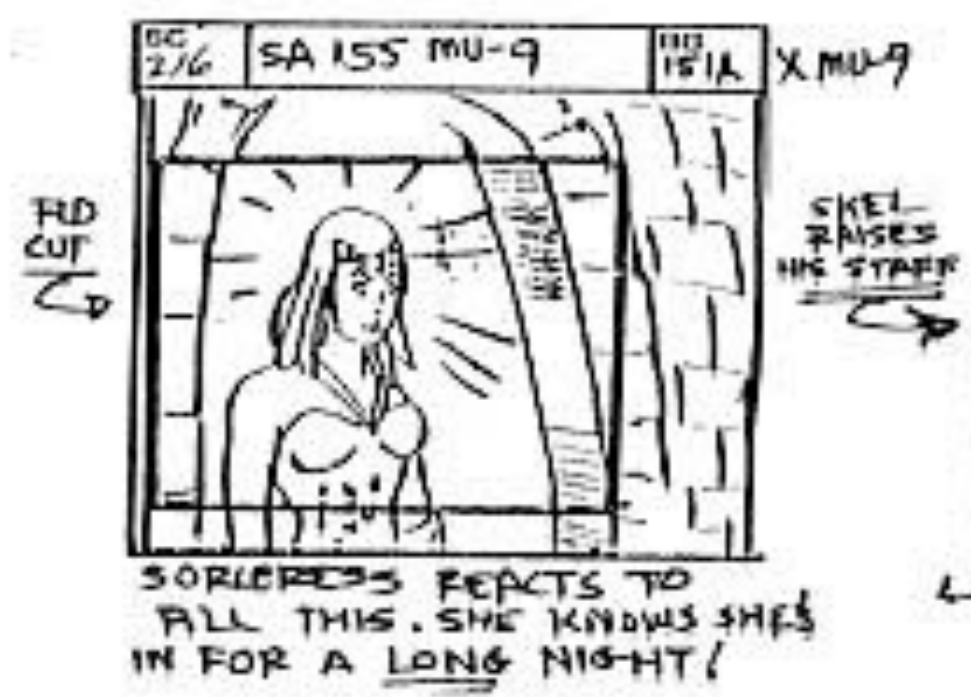
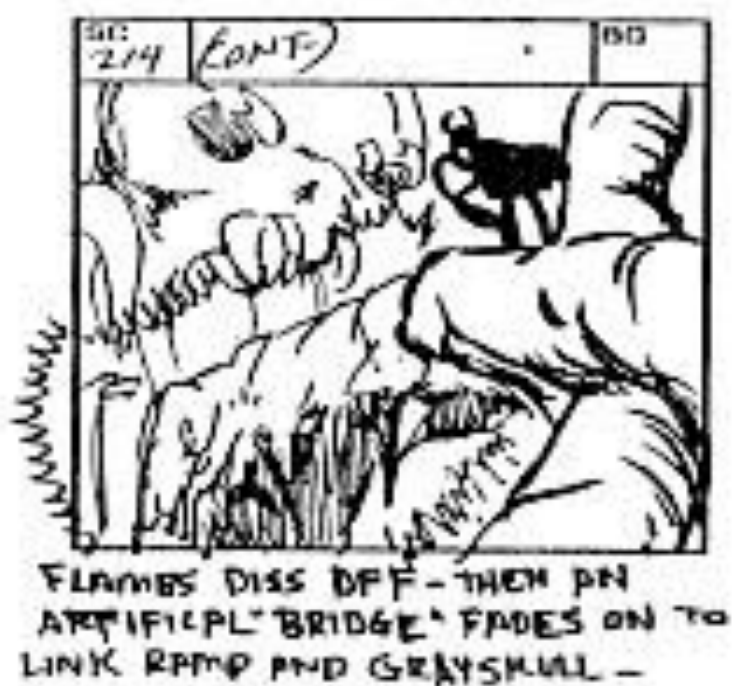
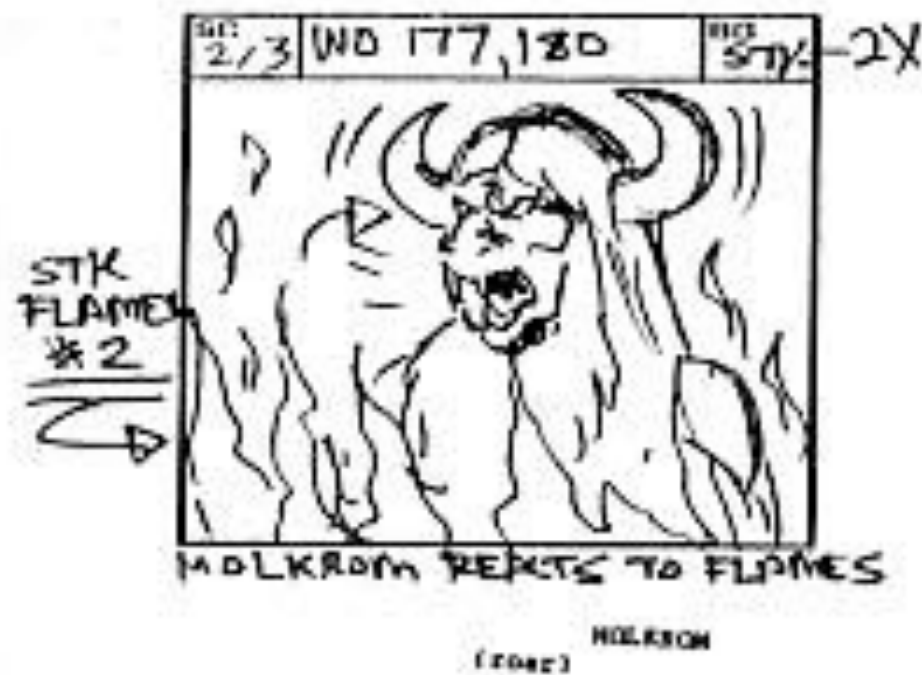





DX  
FX  
CD  
STK  
LIGHTING  
FX 2  
CY

SHEL  
LOWERS  
STAFF

LIGHTNING FLASHES IN  
76G, MALKROM AND FRIEND  
ARE TURNED INTO SILDS.

SHADOW  
EFFY ON  
SKEL S/A  
R 149  
MU-9

HOOK  
UP  
SKEL

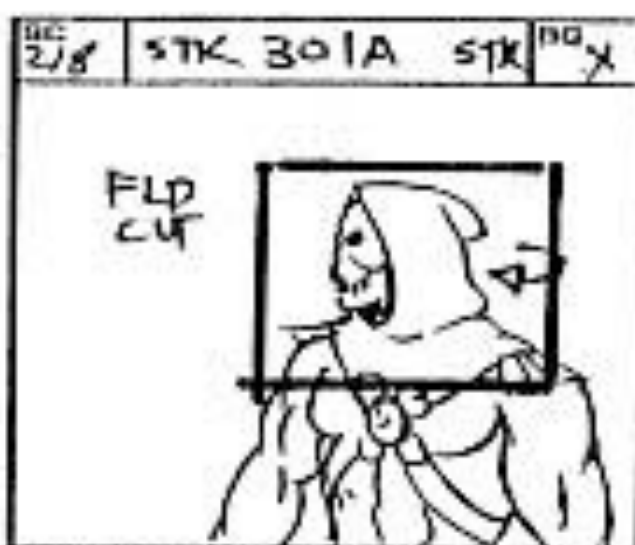

FLD  
CUT

SKEL LOOKS AS  
SKELETON  
How, Malkrom -- break down the  
Jawbridge!

HOOK  
UP  
SKEL



MALKROM REARS W/ A  
VENGEANCE -

RETRACT  
DIAL (roar) MALKROM

ANIMATION  
DIP

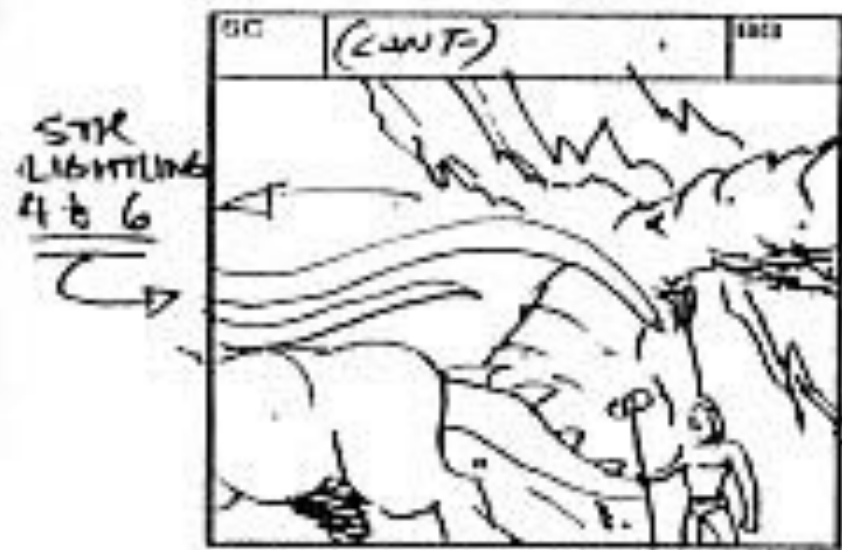

STK  
LIGHTING  
4 to 6

AND CHARGES AS SKEL,  
HOLDING HIS STAFF WATCHES -

SFX: THUNDER !!

TRK  
TRK  
TRK

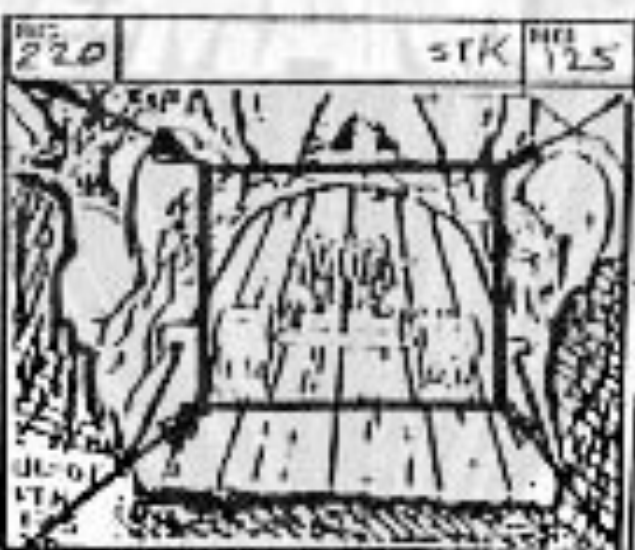

POV OF MALKROM AS HE TRUCK  
IN ON JAW BRIDGE

STK  
OLVL  
125  
STK  
J B  
125



RAMS JB.

SFX: MALKROM'S RUNNING HOOFS APPROACHING W/ GRASSHOP!



MALKROM BACKS AS



MALKROM BACKS INTO SC AND  
REARS ANGERLY

WALKROM

HOOK  
UP  
SKEL



FLD  
CUT

SKELETON  
The castle is strong, but not  
strong enough!





MALKROM CHARGES OS AS A PAIR OF CABLES SHOOT INTO SC -

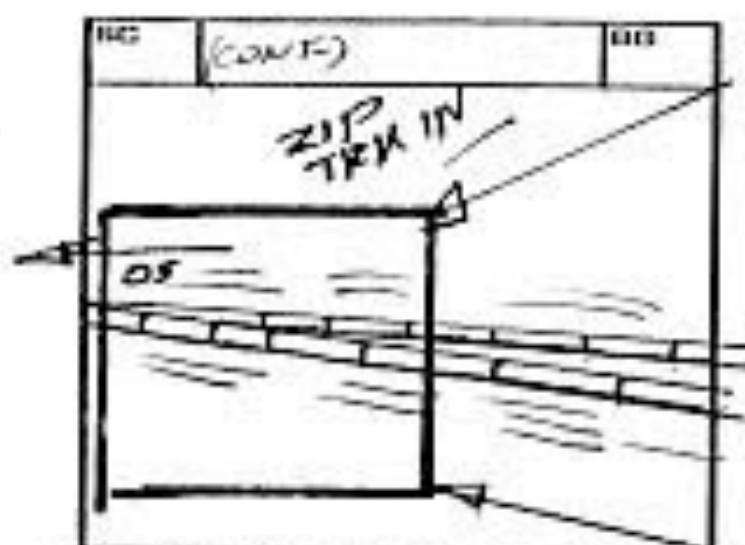

THE CABLES REACH OS AND GO TAUT.



MALKROM IS WRAPPED UP BY CABLES. HE STRAINS TO HIT THE JAWBRIDGE, BUT...



HE IS PULLED HARD OS -



SKEL DOES A TAKE AS THE CABLES PULL DOWN TOWARDS OS.

(A) POS  
SEE SC  
234 FOR  
FULL B  
SET UP.  
DESIGN TO  
WV SES  
228, 232,  
234



PULLING THE CAUGHT MALKROM DOWN THRU SC -



SKEL TURNS AND LOOKS DOWN AS OS MALKROM IS WE HEAR...

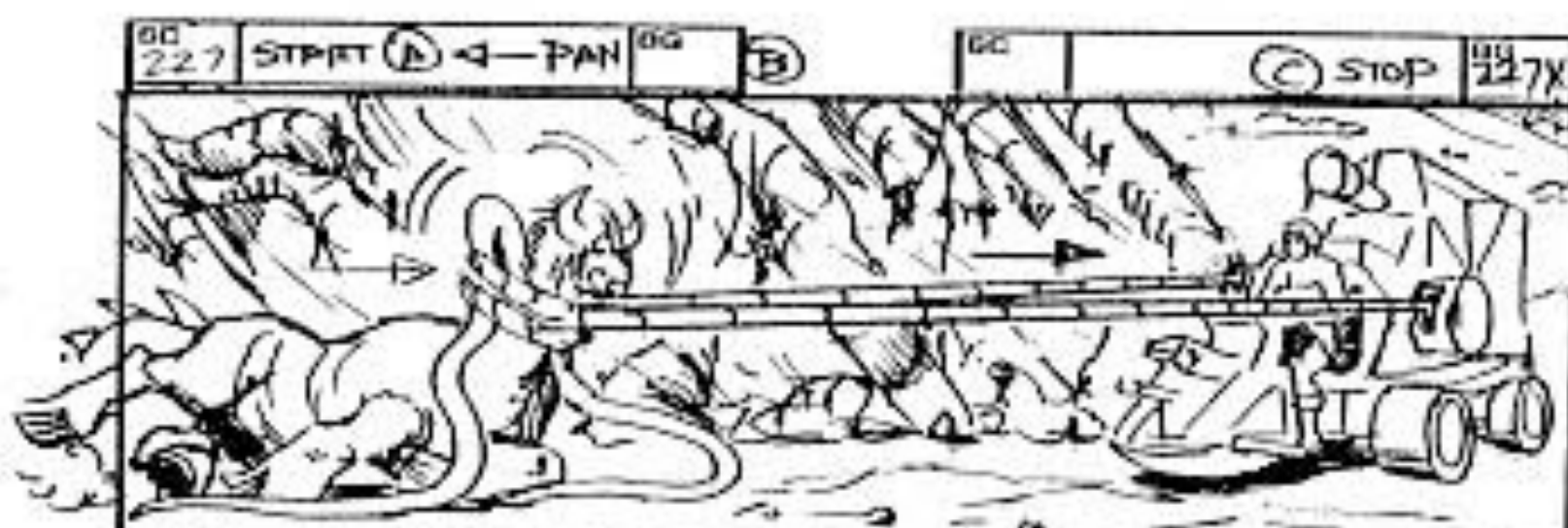

MALKROM IS DRAGGED INTO SC AS HE STRUGGLES W/ CABLET. WE PAN AHEAD TO THE MAN IN BATTLE RAM.

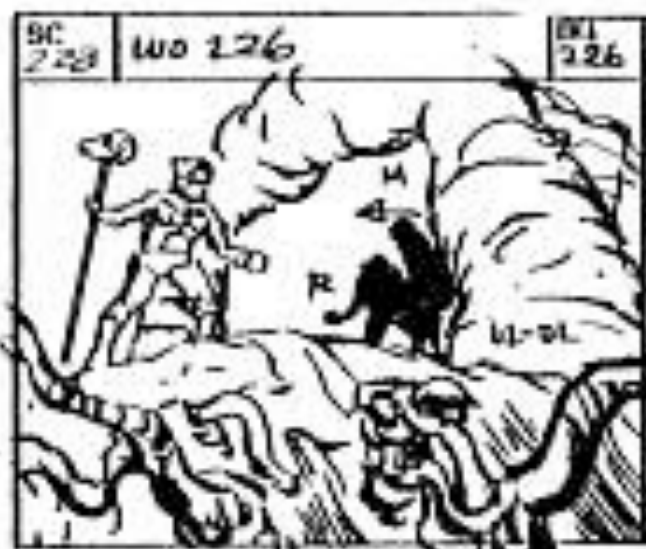

ON SKEL STILL WATCHING AS MALCOLM AS SILOS OF RAMMAN AND M-A-A ENTER TO STOP.



ON SKEL LOOKING DOWN -

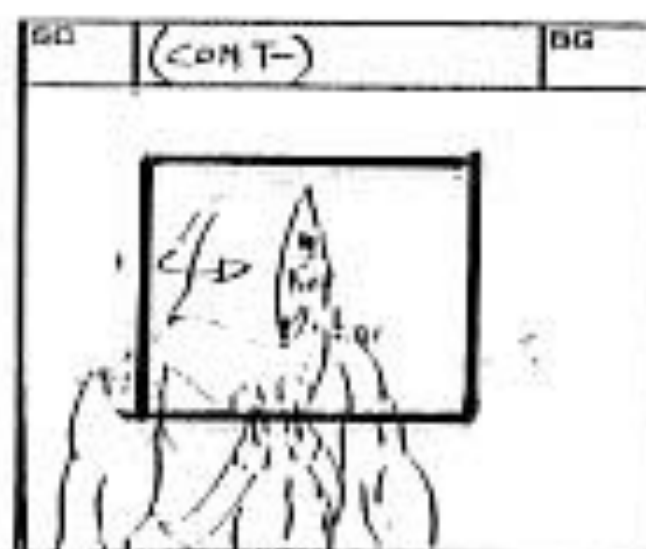

HE REPEATS.

HAN AT ARMS  
Well, well, Skeleton!

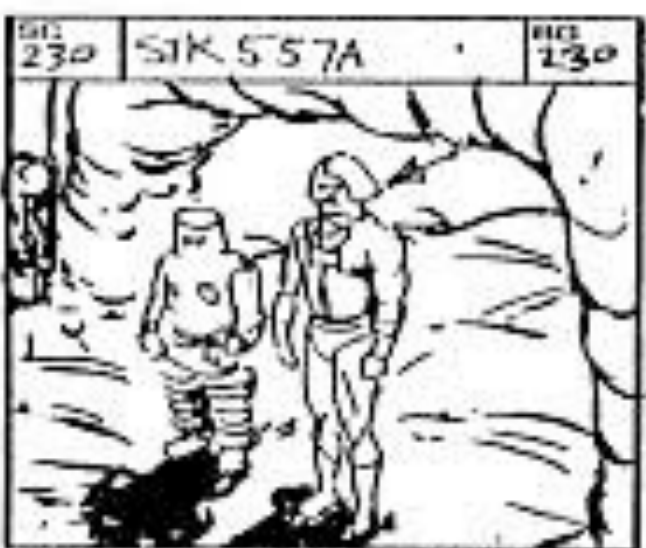

ON RAMMAN AND M-A-A

HAN AT ARMS (cont.)  
It's two against one!



SKELTON  
think so?

ZIP  
TRAY  
OUT  
FULL



SKEL TURNS - FIRES RAM STAFF'S RAY BEAMS -

NOTE  
MALCOLM'S  
BRIDGE  
FROM SC  
214-215



ON PAIR OF EVIL TREES AS -

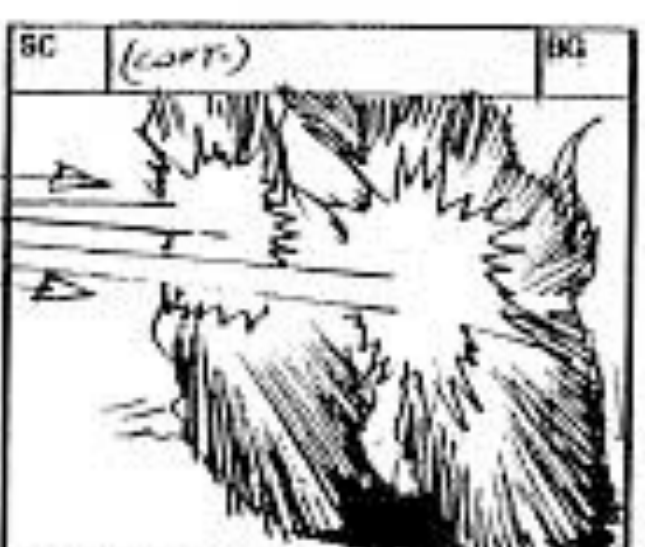

THE RAYS STRIKE THEM -

SKELTON (CG, cont.)  
Cont again!



THE TREES COME TO LIFE, WAVING BRANCHES EVILY

ANIMATION  
M-16

44



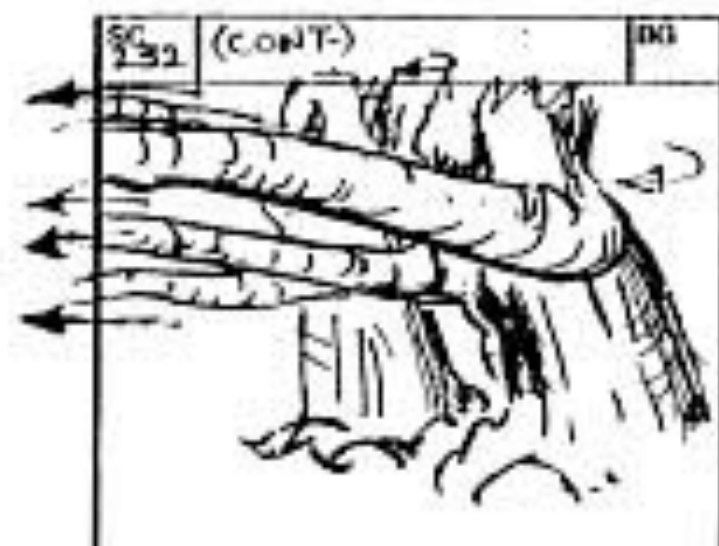

THEY TURN (L) - BRANCHES STRETCH AND REACH OS - HOLD A BEAT -



TALK IN MS WE SEE THE BRANCHES HOLDING STRUGGLING M.A.A AND RAMMAN -

UL-OL  
A30X

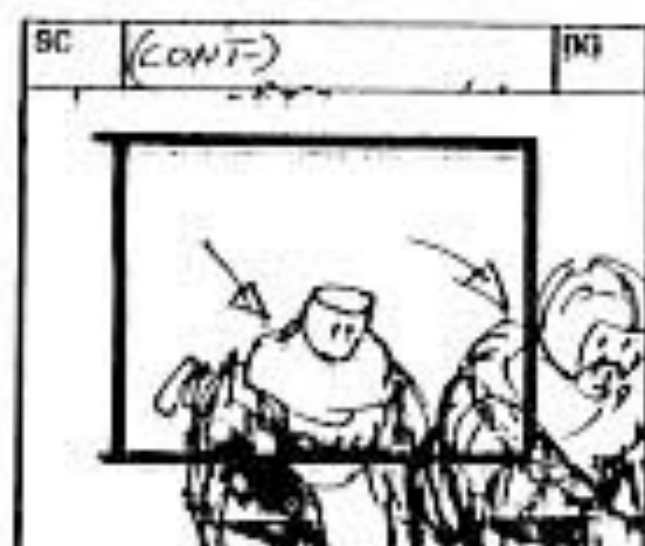

THEY ARE PULLED DOWN AS PAST CAM -

91-NVT

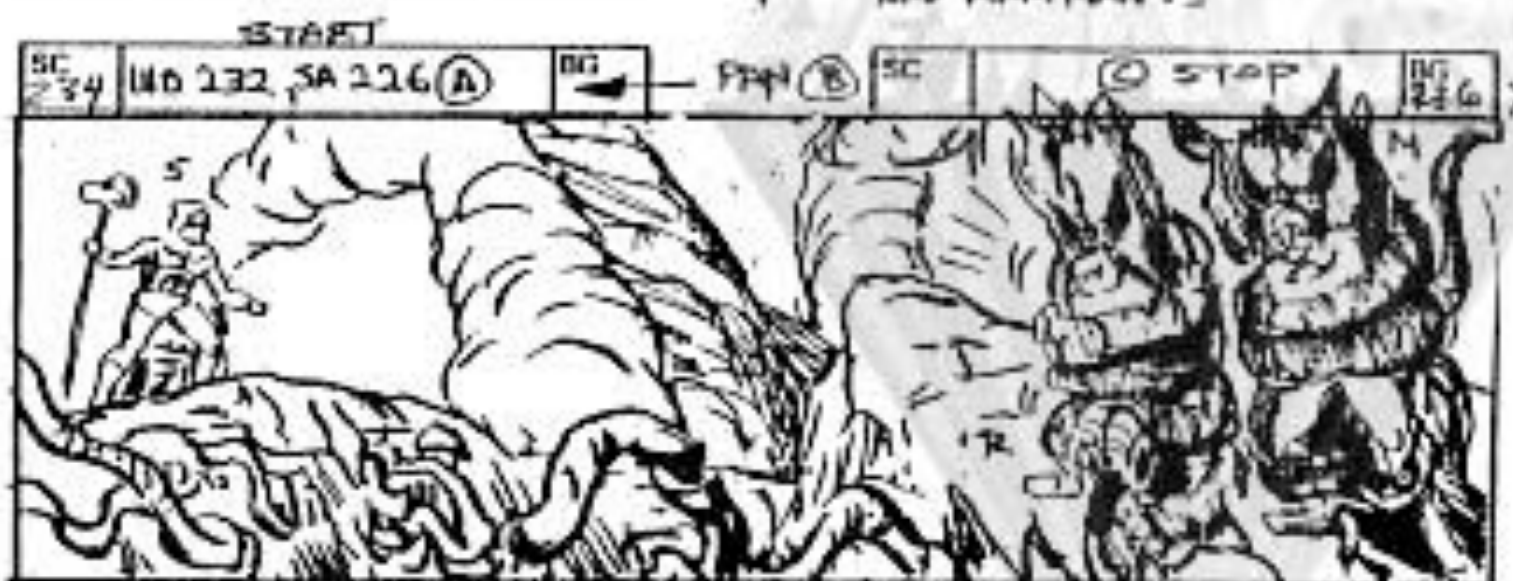

PAN FROM SKEL LOOKING ON TO RAMMAN AND M.A.A AS THEY STRUGGLE IN THE GRIPS OF THE EVIL TREES.



ON MALKROM AS HE STRUGGLE BY CABLE.

HOLKROM  
(FORZ)

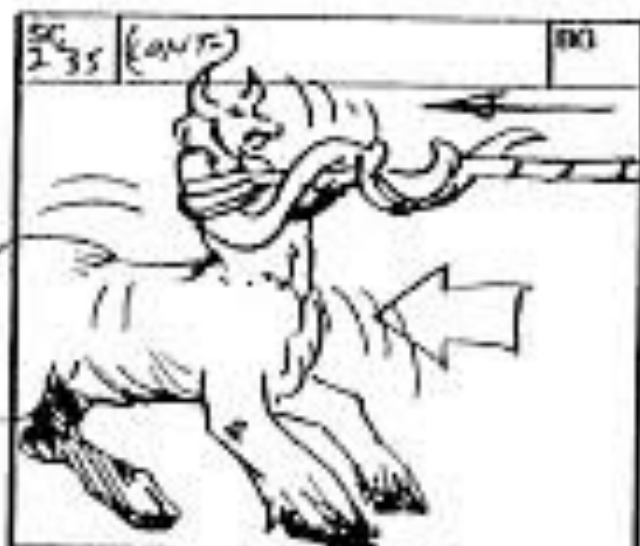

HE GIVES IT A MIGHTY PULL AS HE STARTS TO BACK TOWARDS OS (L)

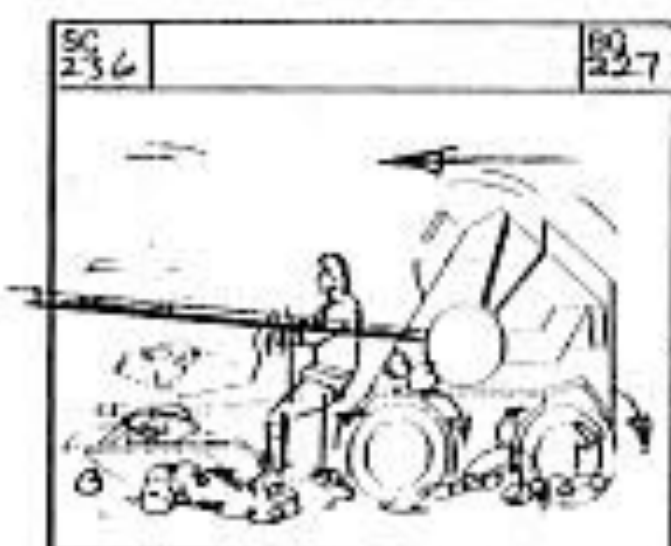

ON HIM IN BATTLE RAM AS HE STARTS TO LOSE THIS TUG-OF-WAR. HE IS PULLED SLOWLY TOWARDS OS -

WHEELS  
SPIN & W  
DUST  
BUILDS  
4



45

ROCK IS  
A SEP  
UL TO BE  
USED IN  
SC'S 241 &  
252



INT TOR& CAVES  
UL-OL 237  
HOOK UP  
EXT-TOR& CAVE VAULT. VON TAKES THE STAFF OF DIVION INTO VAULT AS TOR& GUARDS STAND BY.



TRK 41 FROM GUARDS AT VAULT TO REVEAL DRKO, TEELA, STRATOS AND DELORA WATCHING FROM BEHIND ROCKS.

GROUP  
HOOK  
UP



TEELA TURNS TO DRKO  
TEELA  
Distract the guards. I'll get the staff!

OL 239

MU-16

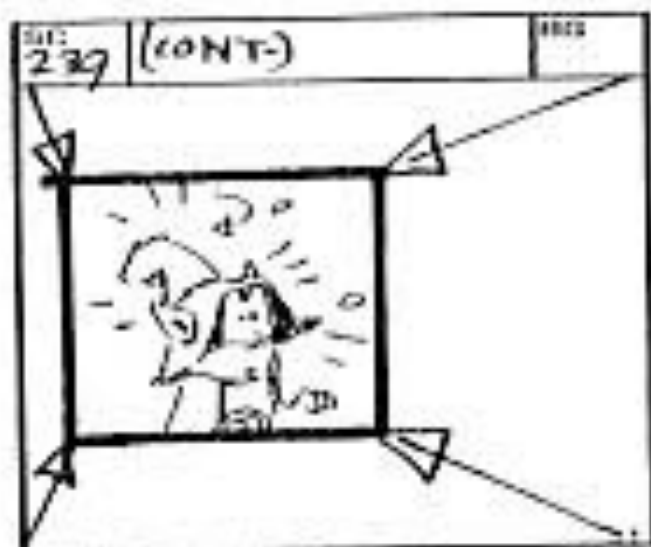

DRKO DOES A TAUNT  
DRKO  
Distract the guards?



TEELA THRU SC

POS

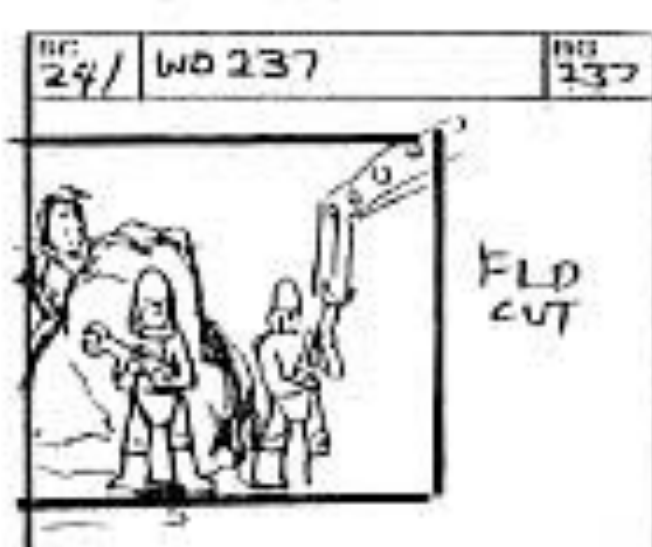

ON GUARDS AS TEELA PEEKS OUT FROM BEHIND ROCK.

UL-OL 237



DRKO I know, I'll try a little maylot



DRKO GESTURES - PIXIE FX FIDE ON -

FLD  
HOOK  
UP



TEELA DUCKS DOWN BACK BEHIND ROCK AS PIXIE FX ENTER SC TO HOVER OVER GUARDS UNTIL...

FX  
IMP  
SC  
TRK  
OUT  
FULL

UL-OL 239

SC CONT

46



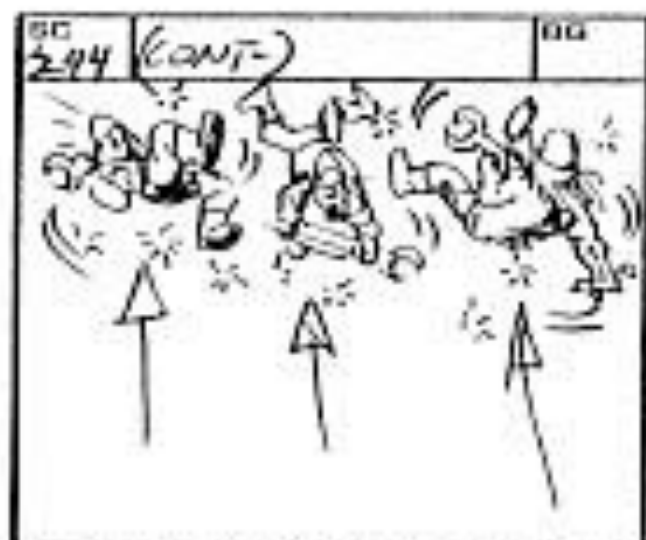

THE GUARDS ARE LIFTED INTO THE AIR - HOLD PMS -  
GUARDS  
(surprised, upset wails)



ORCO  
(surprised)  
Whaddyya know! It worked!

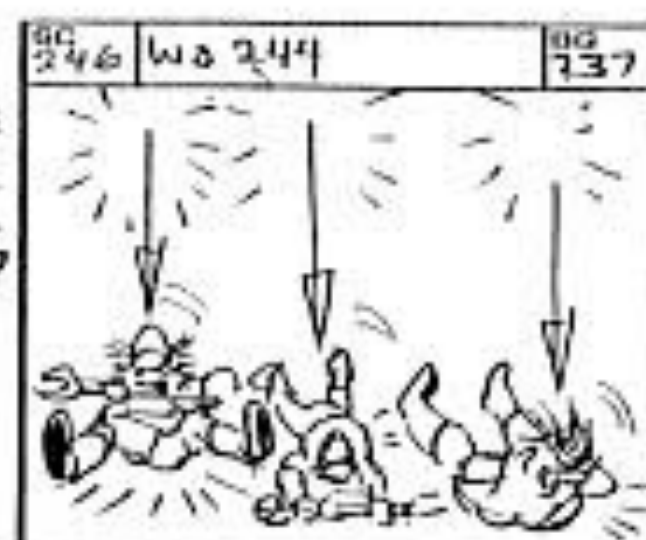

THE PIXIE FLY FADE, CAUSING THEM GUARDS TO FALL BACK TO THE GROUND!

FLD  
FX  
OFF  
N/A

UL-OL  
237

ILLUSTRATION  
MATHY



DELORA, DRKO, AND STRATOS REALIZE THEY ARE BUSTED!!  
ORCO (sob's)  
But not very well!

OL239



GUARDS TURN AS ONE POINTS OF -  
GUARD  
After them!

VAVIT  
UL-OL  
237



ORKO TAKES!

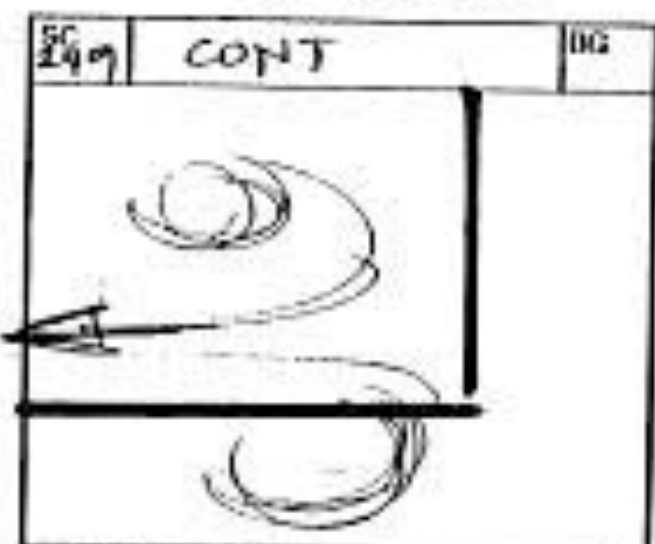

ZIPS OS

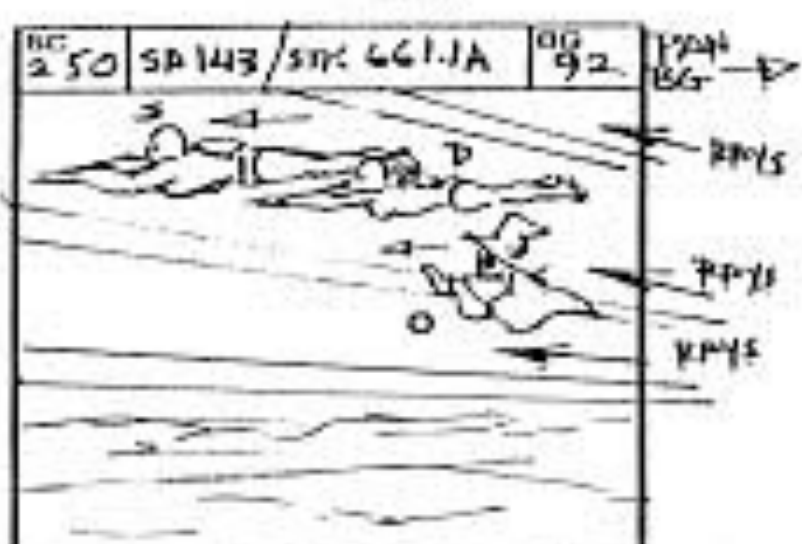

STRATOS, DELORA, AND ORKO SWIM ON PAN AS GUARDS RPYE (LAST THRU SC -

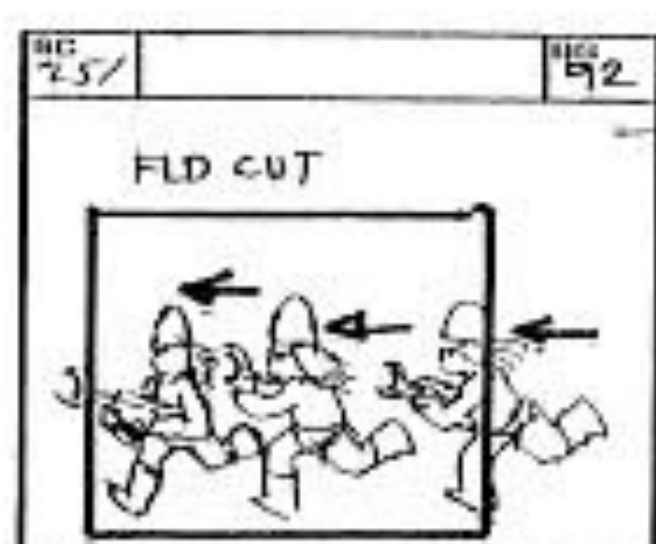

GUARDS RUN, GAIN ON PAN.

UL-OL  
237

47



ON VOH REPORTING TO OS GUARDS AS TEELA APPEARS FROM BEHIND REAR.  
 VOH  
 What's going on?

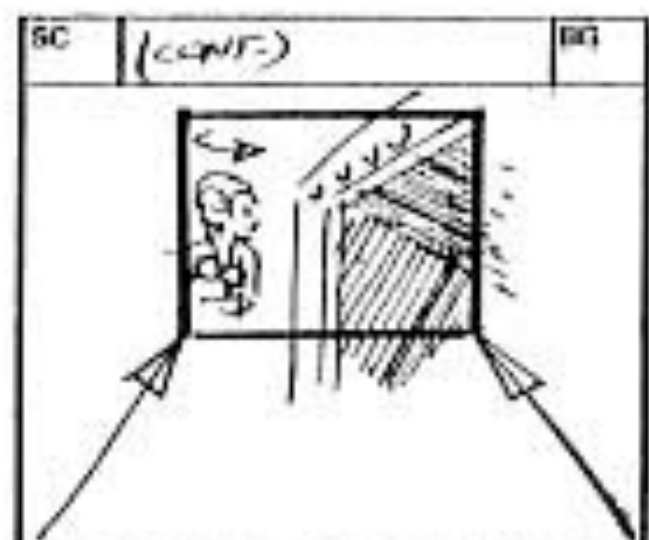

TRK IN PS SHE LOOKS INSIDE THE VAULT -



TEELA STOPS INTO SC INSIDE VAULT DOORWAY -

(A) POS INT. VAULT UL 254

FINISH - 10



PAN FROM HEX ACROSS THE INTERIOR OF VAULT, FILLED W/ TONS OF JEWELS, GOLDEN STATUES, AND ETC. IN (B) PS WE SEE THE STAFF OF PYLON STANDING AGAINST THE WALL -

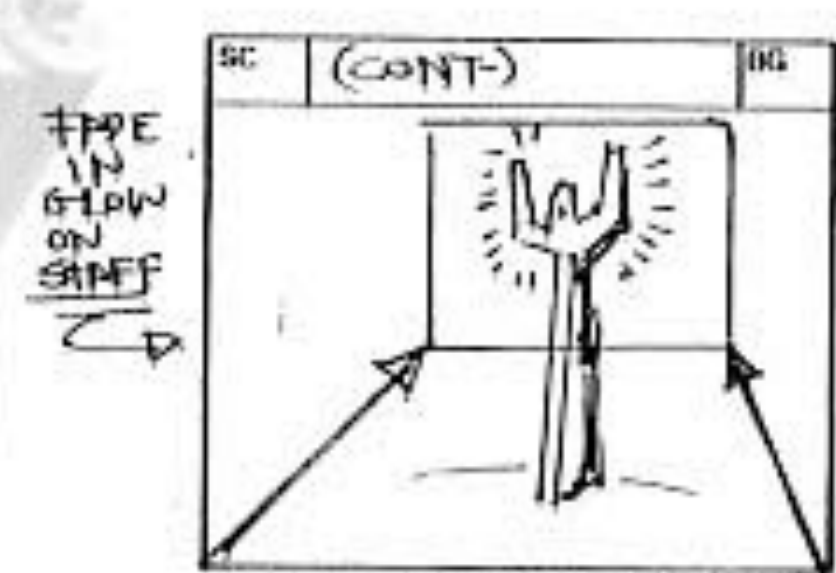

TRK IN PS IT BEGINS TO GLOW

FXE 258 258 STAFF

FXE IN SECOND COLOR TWICE  
 FX OFF

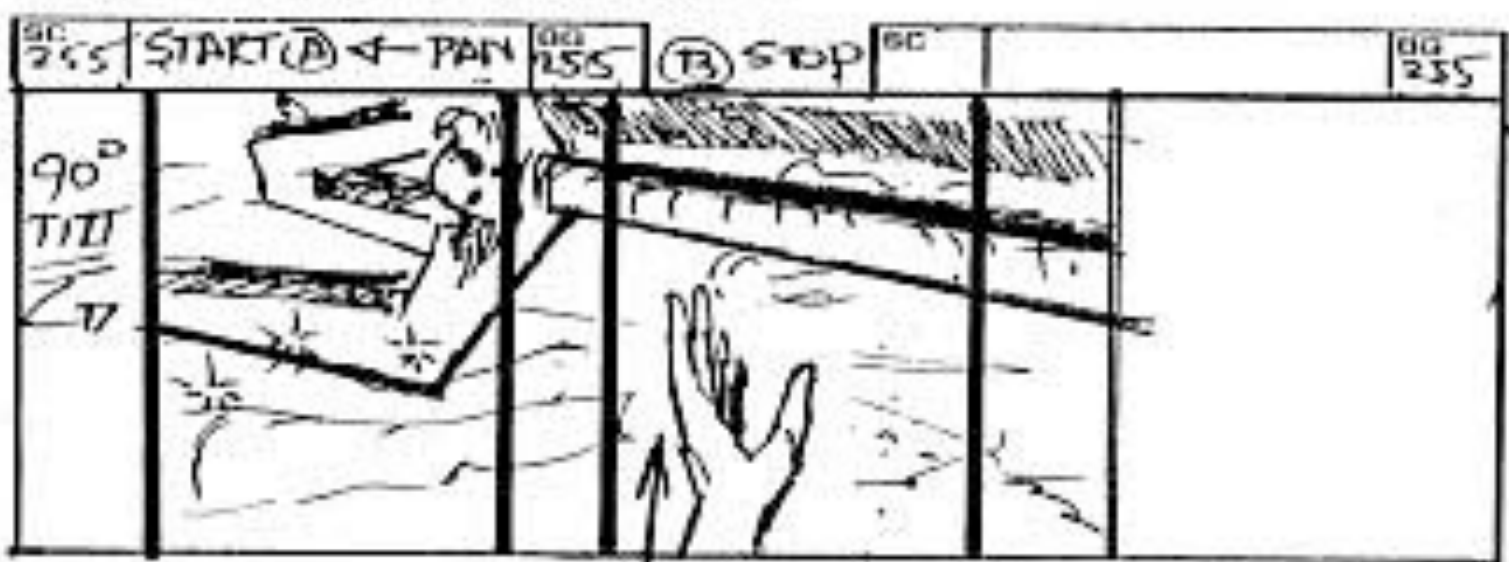

CLOSER ON STAFF. PAN DOWN AS TEELA'S HAND REACHES INTO SC FOR IT -- BUT --

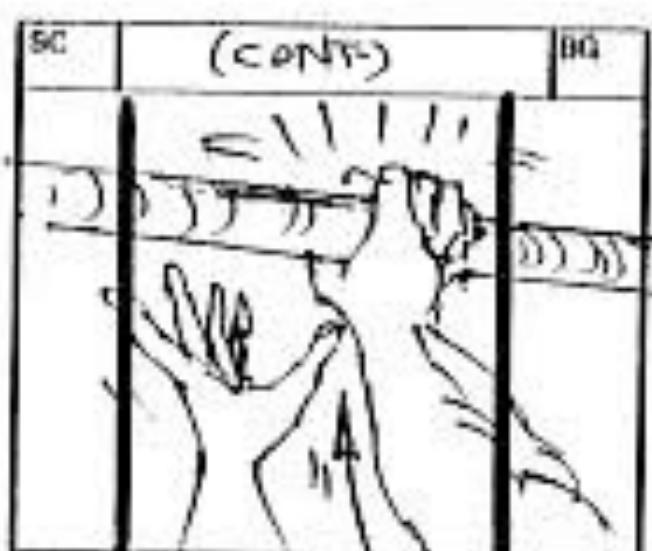

VONS (B) HAND ZIPS INTO SC TO GRAB STAFF...

SC CONT (B)

NOT TO FAST!



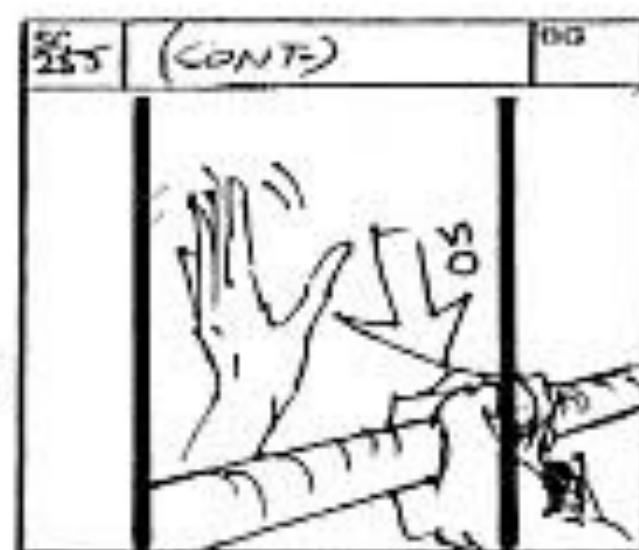

VON TAKES IT QUICKLY OS-HOLD ON TEXLA'S SURPRISED HAND A BEAT



VON HOLDS STAFF AND A JEWEL CLUB.

TEXLA !!  
Give me that staff!

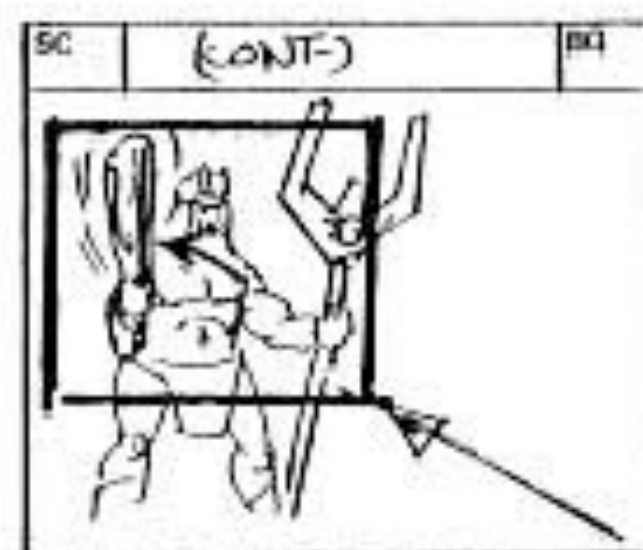

VON WAVES CLUB.

VON  
I'll give you this instead!



TEXLA BRACES FOR ATTACK

TEXLA  
I told! Why aren't things ever easy?



VON WAVES CLUB INTO SC IN FOREGROUND.

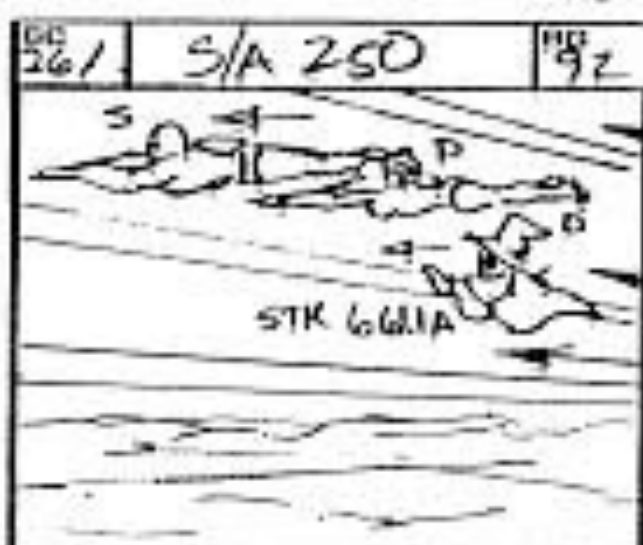

MEANWHILE, OUR HEROES CONTINUE DOWN THE CAVERNS AS PAYS RUNS THRU SC.

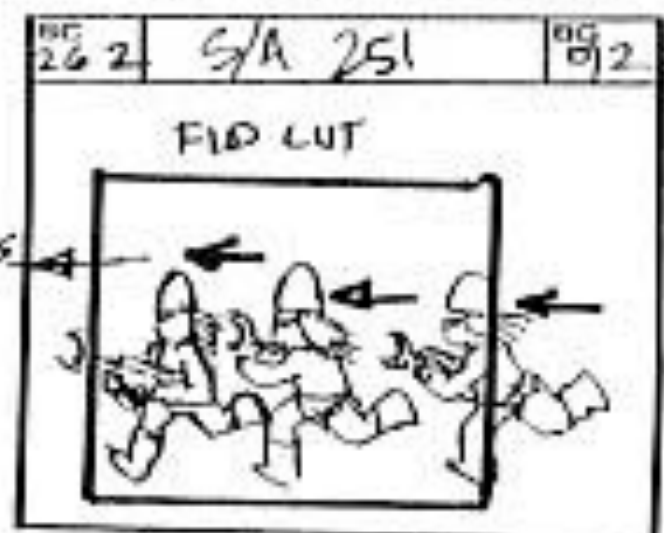

THE TORG'S GAIN THRU SC FAST.



STRATOS  
I'll hold them off!



THE TORG GUARDS APPEAR FROM BEHIND ROCKS.

SUBSCRIPTION 10

PAN BG

PAYS

PAYS

BG-PAN  
① to ②  
→ GRADUAL SLOW TO STOP

49



STRATOS INTO SC - FIRES LASERS.  
SFX 1 2 3 4 5 6 7 8 9 10



THE TORGS QUICKLY DIVE ON

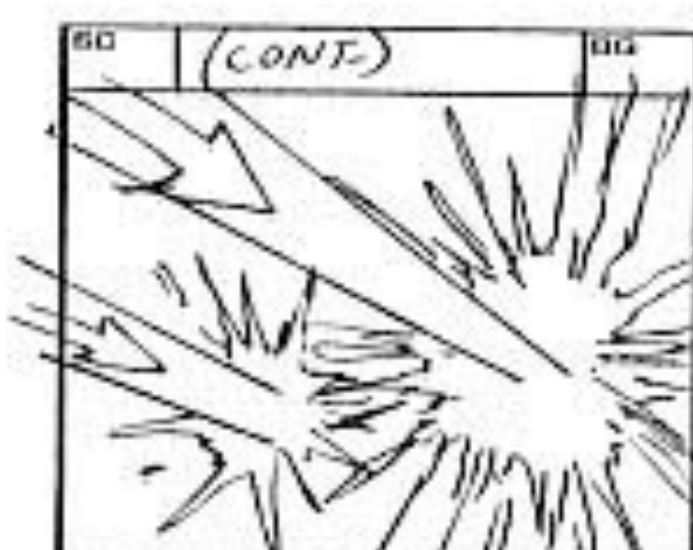

JUST AS STRATOS LASER BEAMS STRIKE THE ROCKS -

MUTANT



TORGS BACK UP INTO SC AND FIRE THEIR WEAPONS.



STRATOS HOVERS AND FIRES HIS LASERS AS TORGS RAYS BLAST THRU SC -

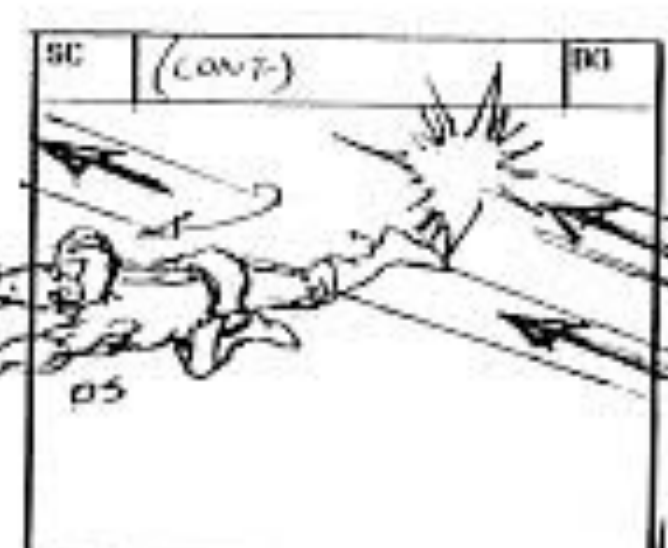

STRATOS DECIDES THIS IS A GOOD TIME TO RETREAT!



STRATOS FLIES BEHIND A LARGE STALACTITE



HE REAPPEARS AND BRACES AS RAYS STRIKE ROCK.



STRATOS  
I have a feeling this wasn't a good idea



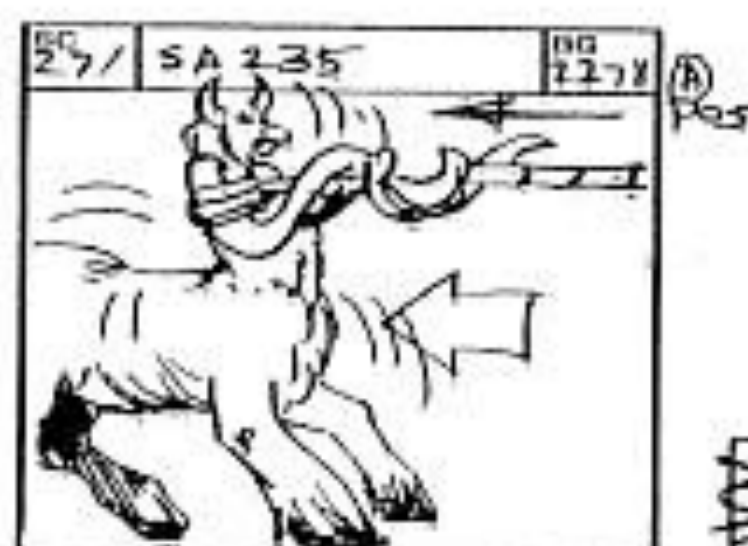

OUR HEROES CONTINUE TO STRUGGLE W/ TREES -

MOLKROM PULLS CABLES -

STATION 4  
A-1-10

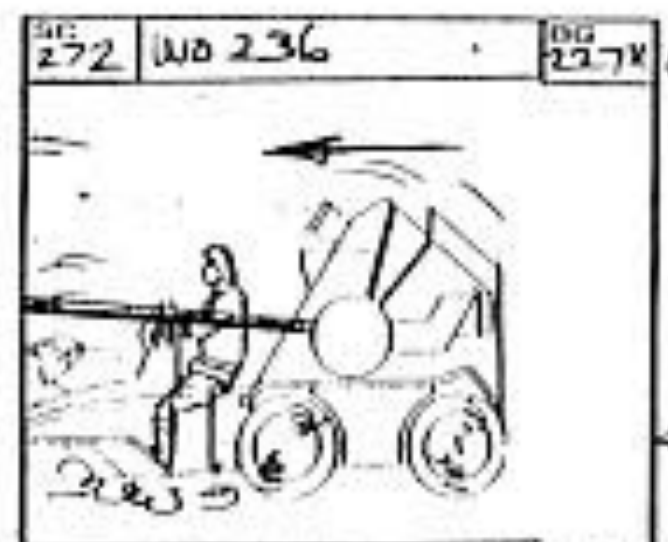

WHEELS SPIN CW

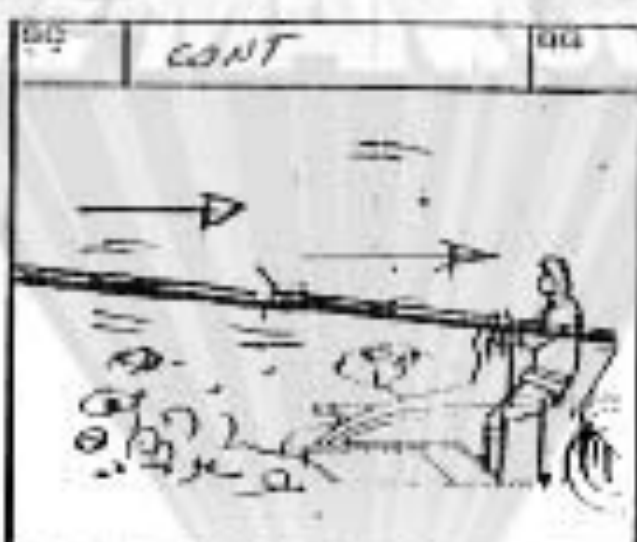

THE TUG OF WARR continues AS HM IS PULLED -

BATTLE RAM PULLS BACK TOWARDS OS



MOLKROM STRAINS ... THEN ...



USING ALL HIS AWESOME POWER, HE YANKS THE CABLES HARD

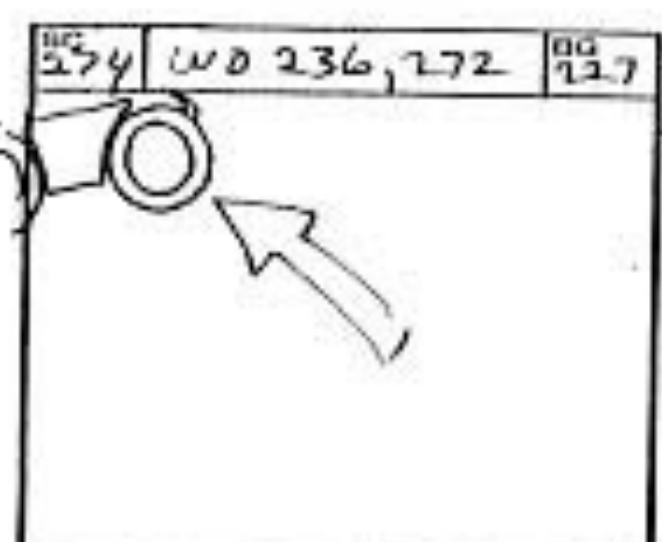

HERMON AND BATTLE RAM ARE PULLED UP AND OS FIRST!

CABLES ARE SEPARATED

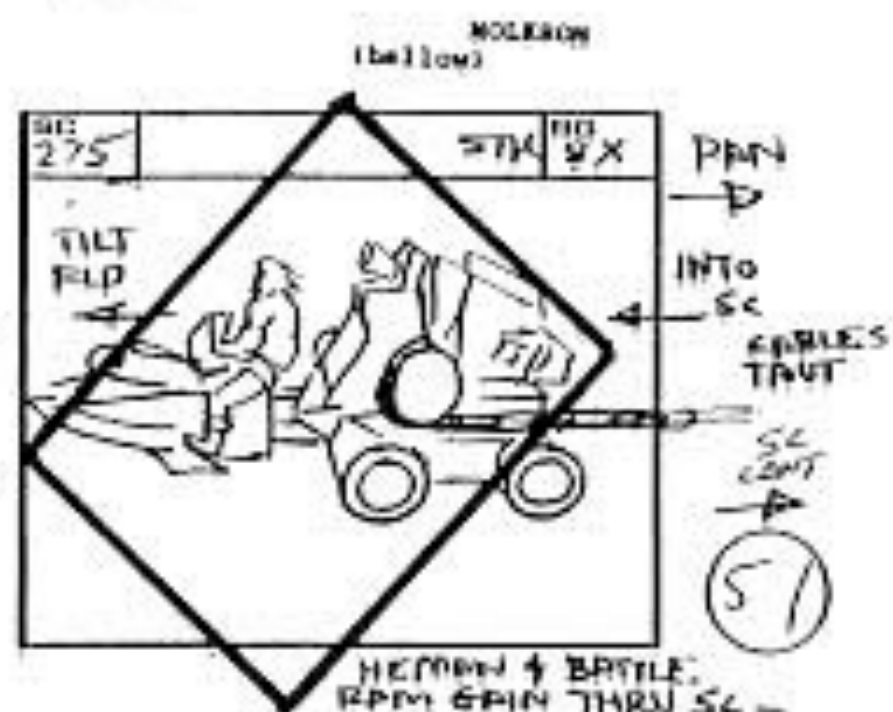

51

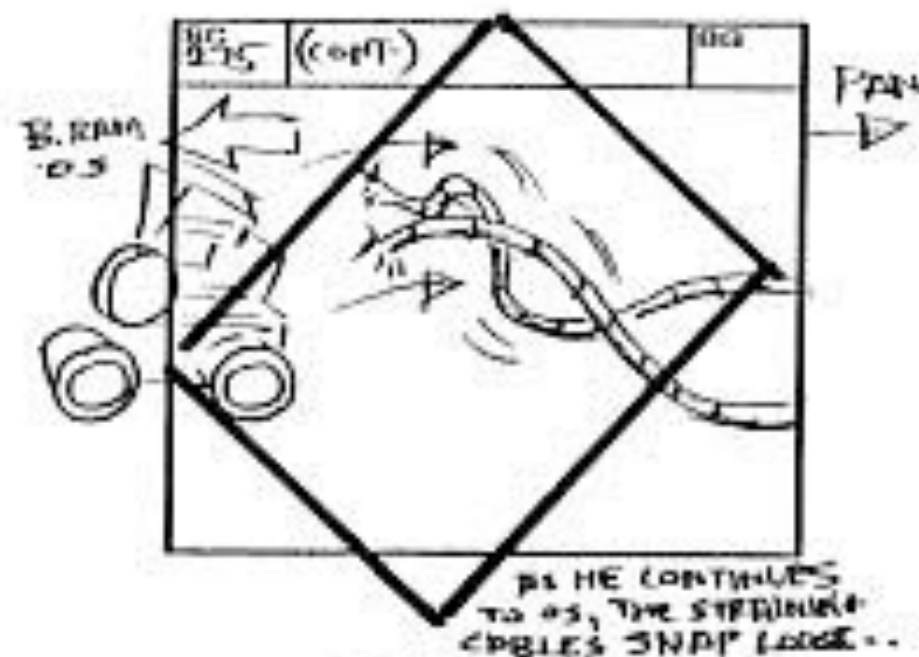

SFX: SNAP!!

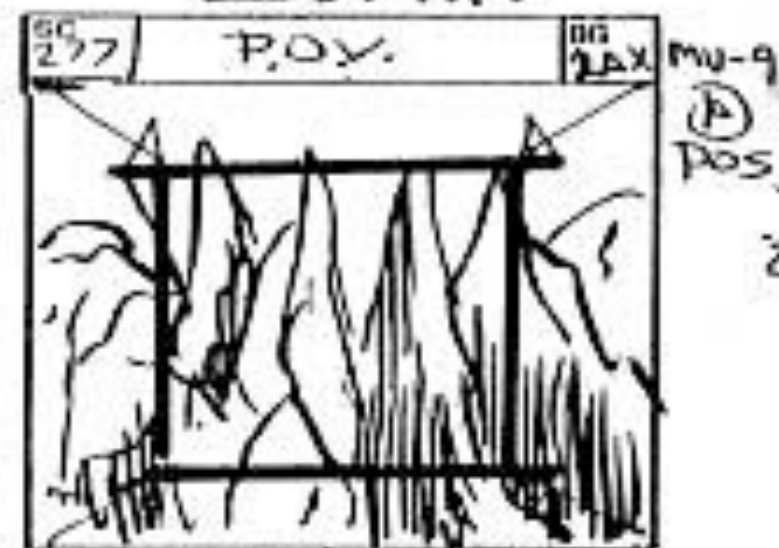
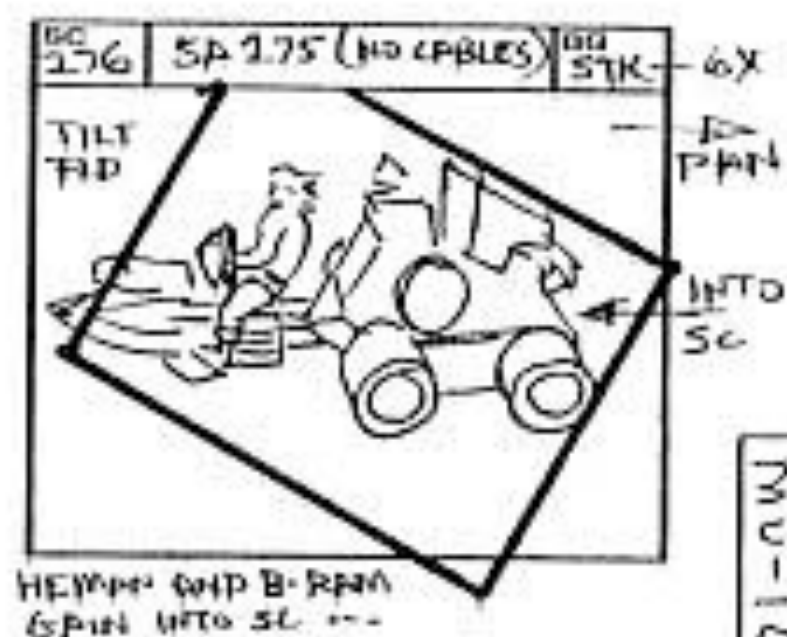
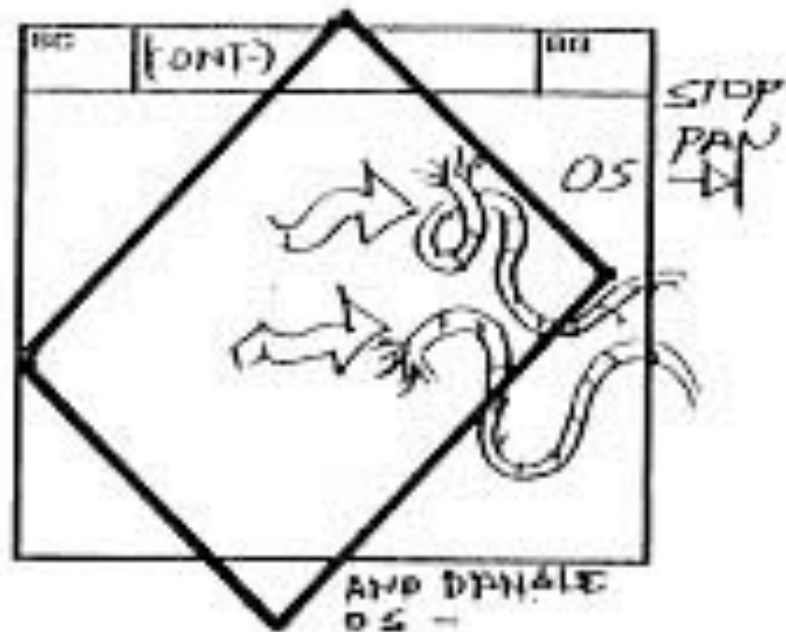

SFX: CLICK!!

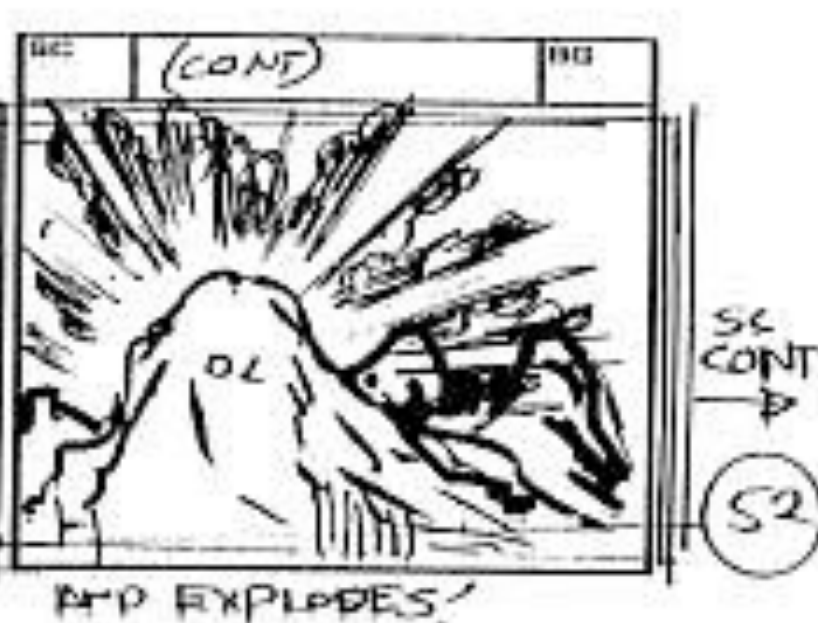
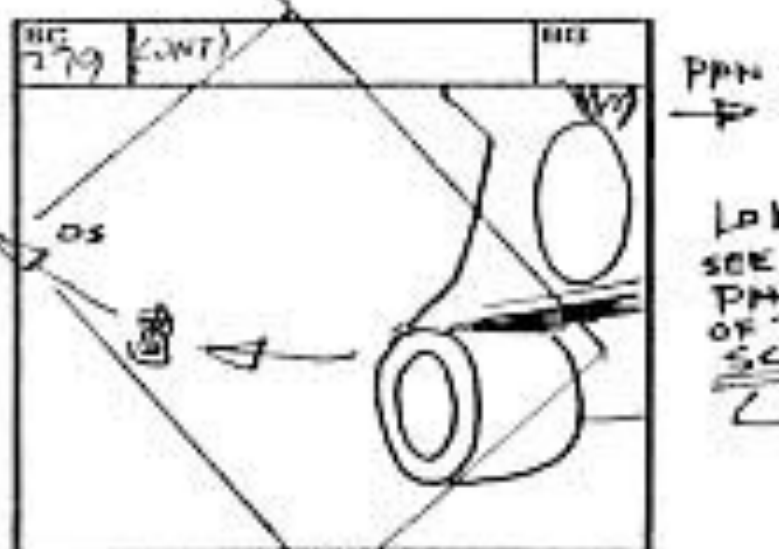
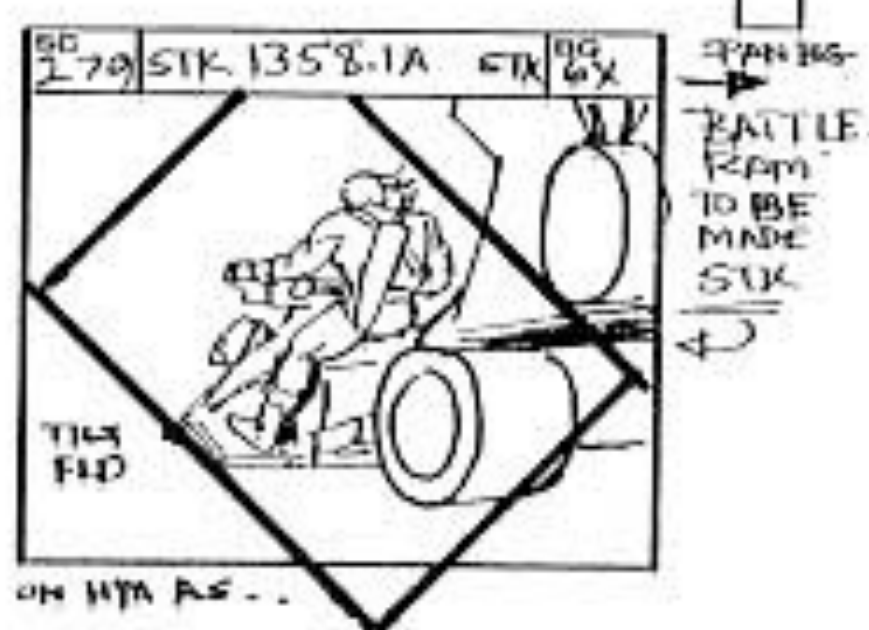



NOTE:  
DESIGN  
OF SO  
WE SEE  
ONLY A  
PORTION  
OF STK  
FLAMES

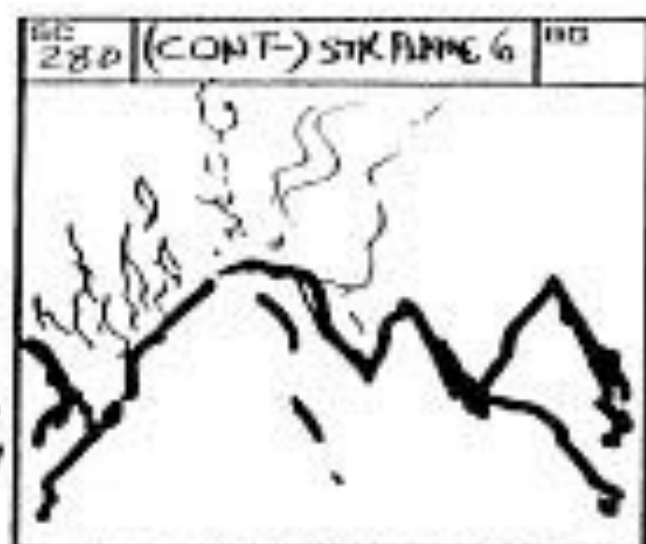

HOLD A BEAT ON SMOLDERING MOUNTAIN.

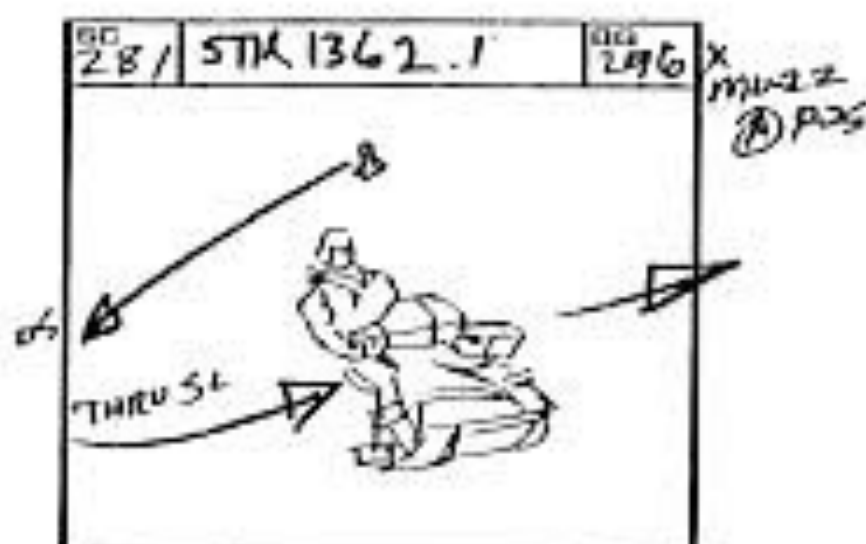

HIM SCOOPS AROUND THRU SC

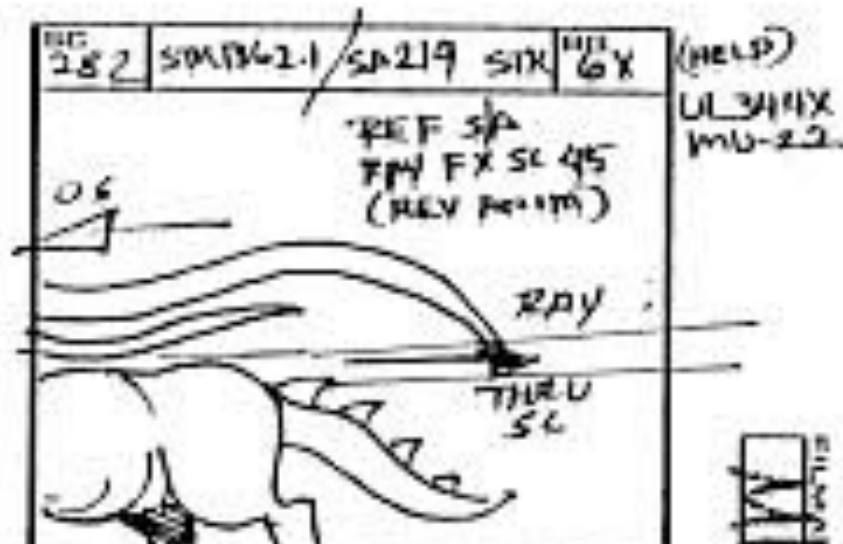

MOLIKRAM RUNS BY JUST AS OS HE HOPS SKY SLED RPY BLASTS THRU SC -

MILKIP

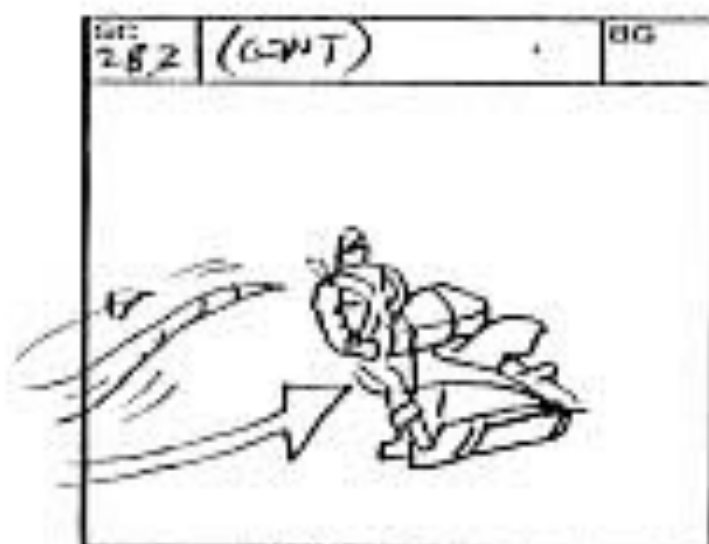

HE HOP SKIPS INTO SC AS ONE OF MOLIKRAM'S ARMS STRETCHES INTO SC -

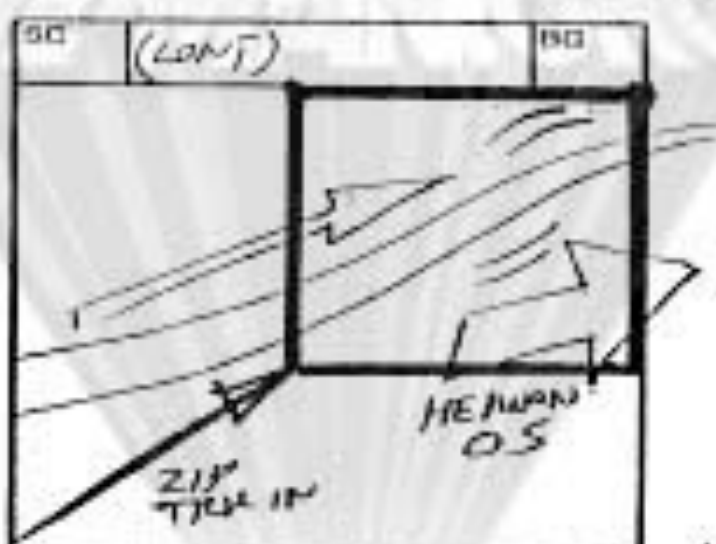

AND HIM CONTINUES OS, MOLIKRAM'S ARM REACHES OS, FOR A LITTLE TAUT -

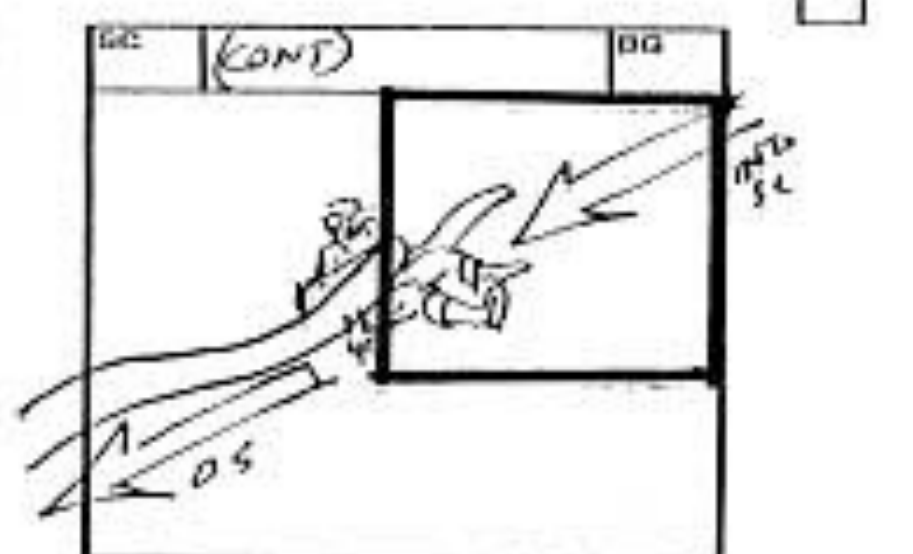

ARM PULLS BACK THRU SC W/ SURPRISED HEMAN -

RAY1 HEMAN



EVIL MOLIKRAM BRINGS THE STRUGGLING HEMAN INTO SC TO HIMSELF, FAINS GLARE.

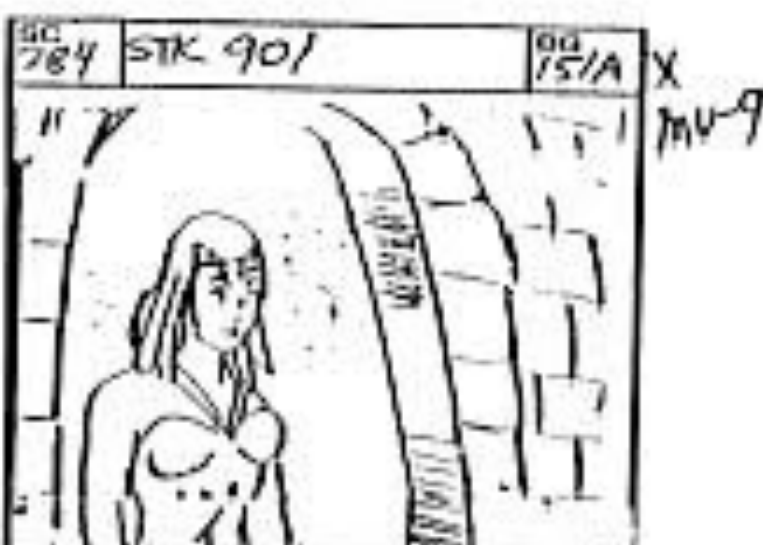

WARRIRESS LOOKING DOWN. SORCERESS  
Ee Kan needs my help!

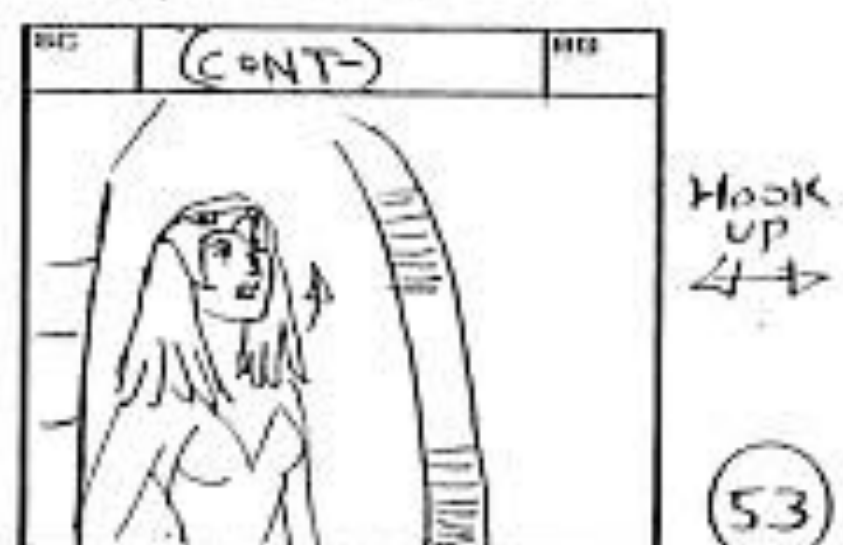

SHE LOOKS UP

Hook up  
44

53



WOLFESS RAISES ARMS, FX FILL WINDOW -

MU-9  
UL-OL  
150X  
MU-9

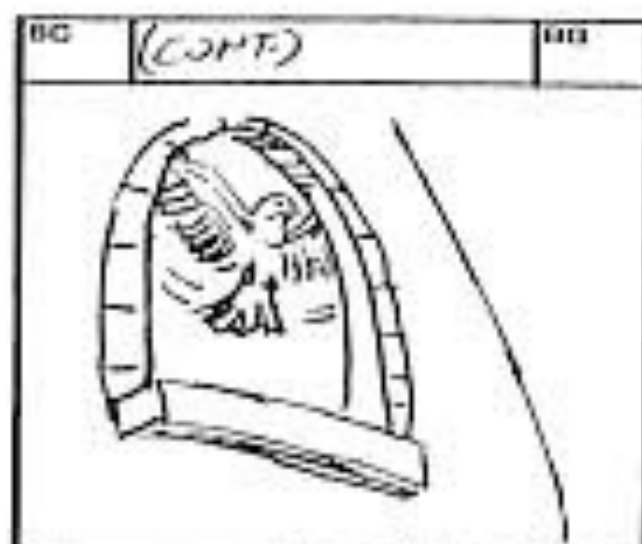

TURNS INTO THE **FALCON!!**

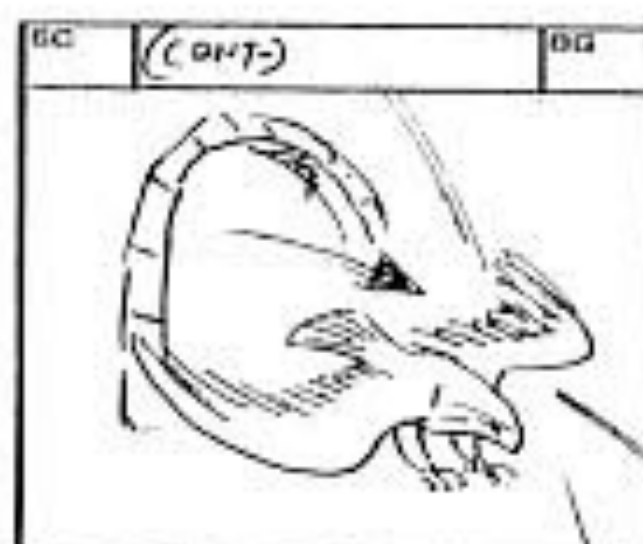

SHE DIVES OS -

FILMATION



MOLKROM REACTS TO OS ZONE AS HE CONTINUES TO STRUGGLE IN HIS ARM. -

(HELD)  
UL 394X  
MU-12

STK LIGHTNING  
FX 446

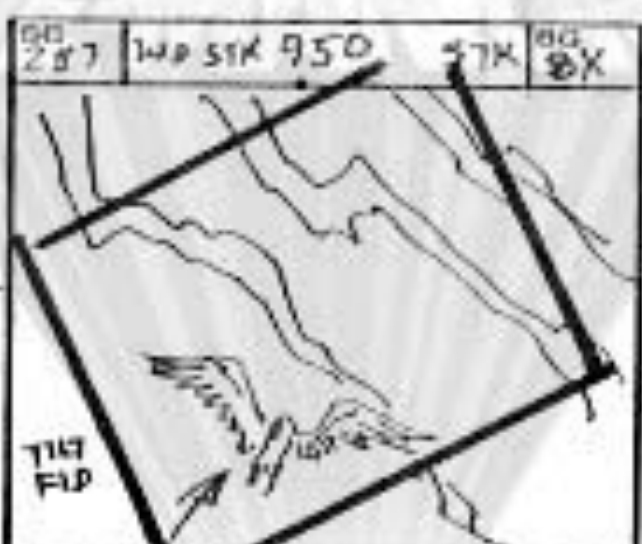

LIGHTNING FLARES IN BG - OS ZONE SWOOPS UP INTO SC -

(HELD)

EXPOSE WHITE ZONE SOPS

DX EX CD



SHE HOLDS POSITION AS A MASSIVE FLARE EXPLODES FROM HER, FILLING SC.

FADE IN SLOW FX



MOLKROM REACTS TO THE BLINDING FLARE AS HE DROPS THE MAN.

FX SLO SC 174 FLOPPY CD



HE COVERS EYES W/ ONE ARM AND SWINGS THE OTHER ARM UP AND OS.

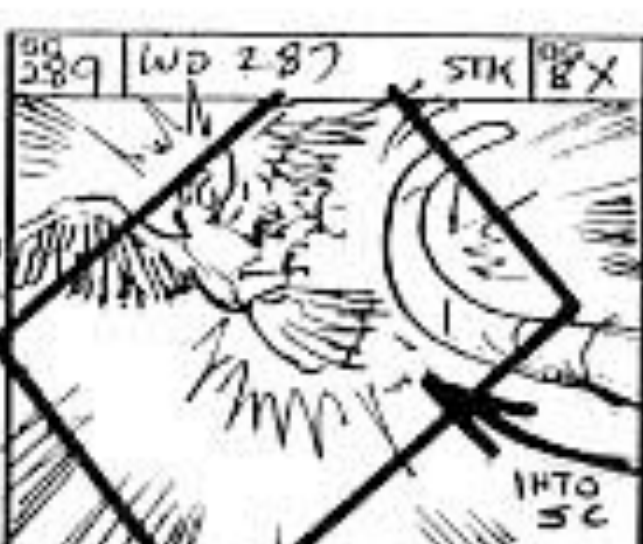

MOLKROM'S ARM SWINGS INTO SC AND STRIKES ZONE -

SC CONT

54



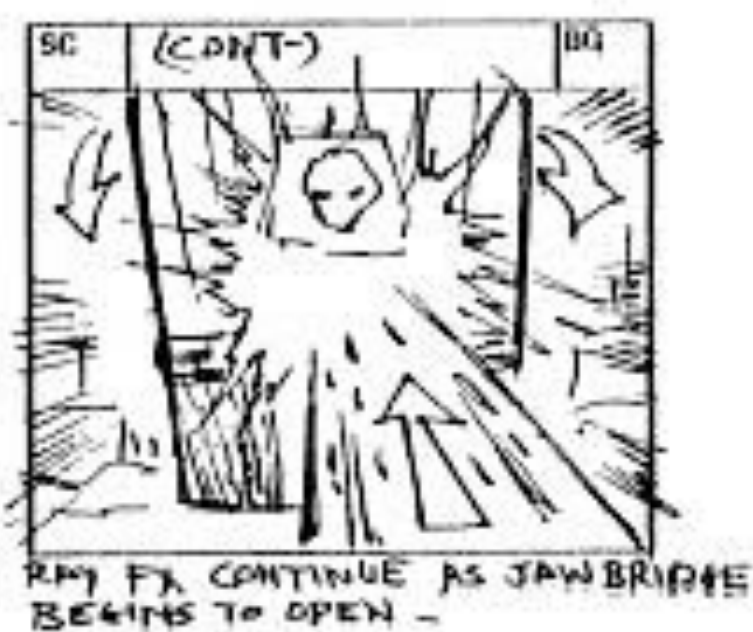
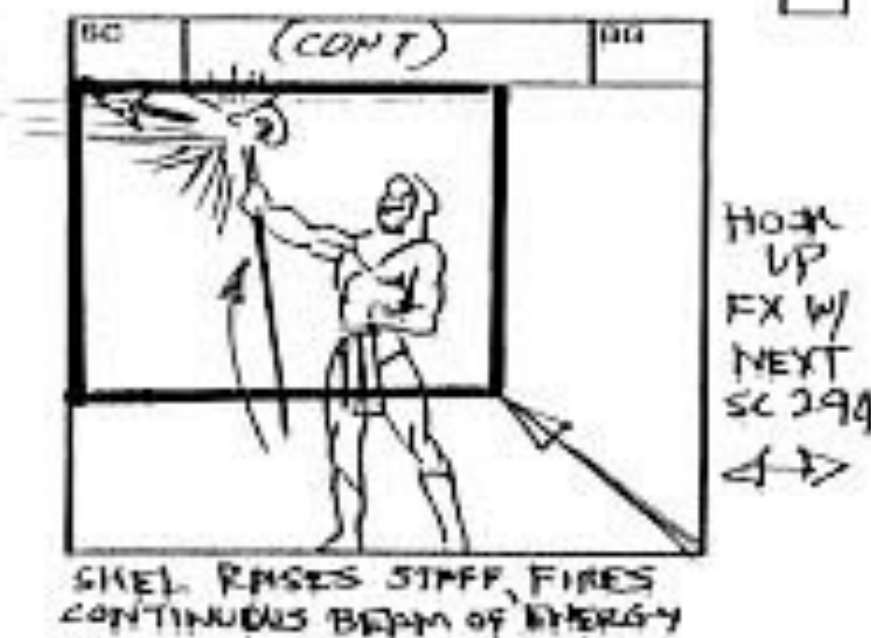
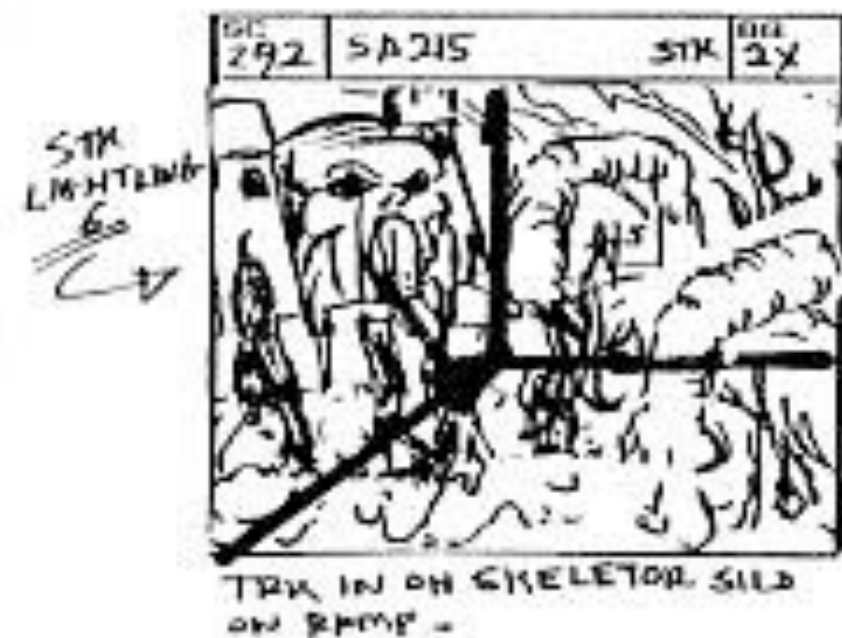
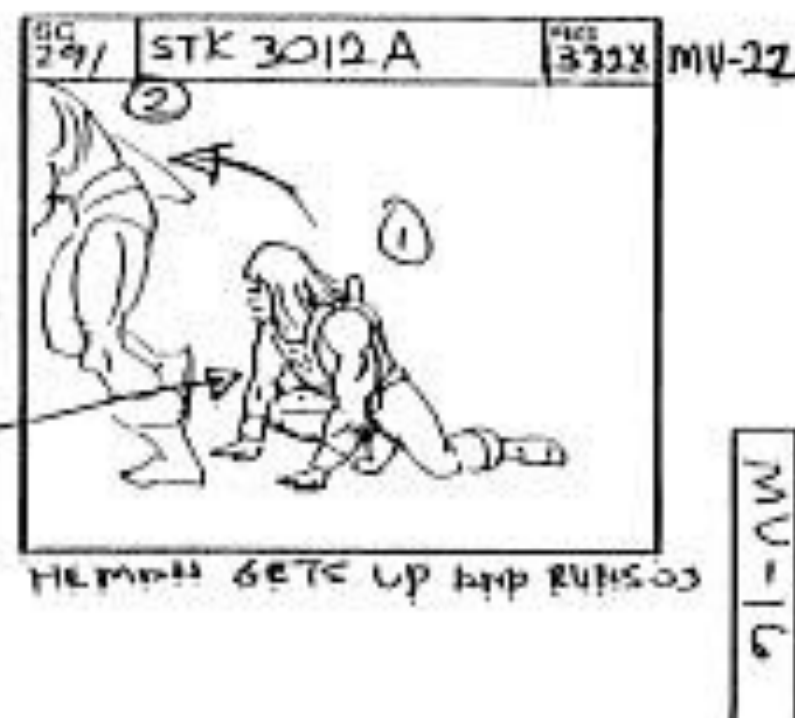
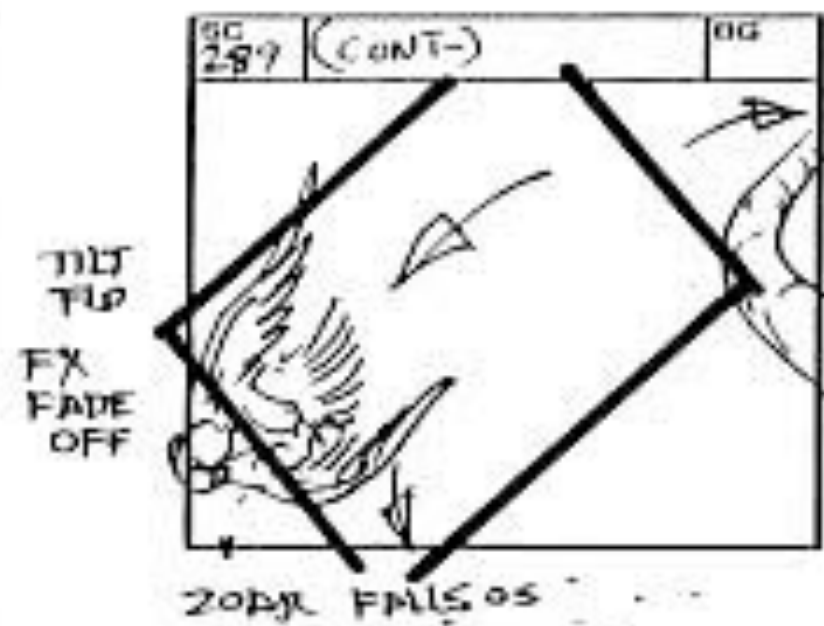

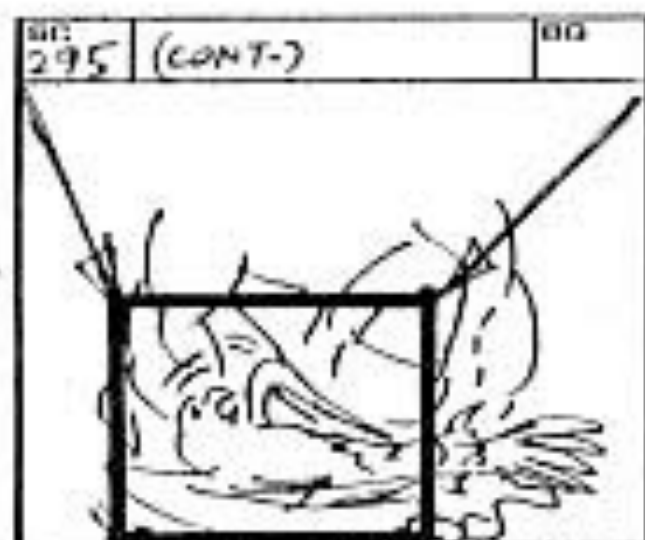

ZOOM IN ON ZORR AS SHE RECEIVERS

ZORR (VO)  
No, I'm alright!



HE MAN REACTS AS LIGHTNING FLASHES IN THE

SEX THUNDER



ON SKEL FIRING RAYS

AS HAS (VO)  
Better get back in Graykull, Skeletor's trying to enter!

MU-9  
UL-01  
145A  
MU-9

SITUATION  
AND TONE



RAY'S STRIKE JB. IT OPENS SLIGHTLY

MORE... AS HAS (VO)  
He'll use all his power!

STK JB 111X



ZORR SWOOPS THRU SC AS HM ENTERS

STK LIGHTNING FX 2  
4X



HM STOPS.



TICK IN ON GRAYSKULL TOWER. LIGHTNING FLASHES -

UL-01 207X  
EXPOSE WHITE CPD 30% ON 2ND PASS FOR LIGHTNING FX  
4X

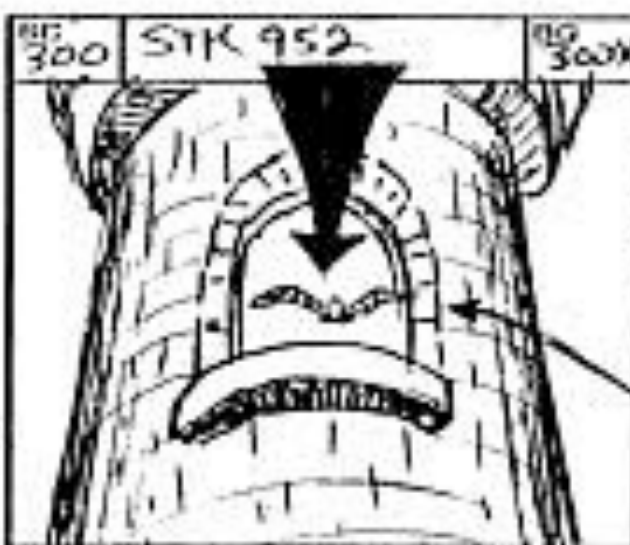

CLOSER ON TOWER AS ZORR SWOOPS INTO WINDOW.

DIR: CUT TO NEYTS WHEN THE FALCON IS HERE



HM MAN PULLS OUT SWORD

MOLERON (OP) (CONT)

(B) POS

56



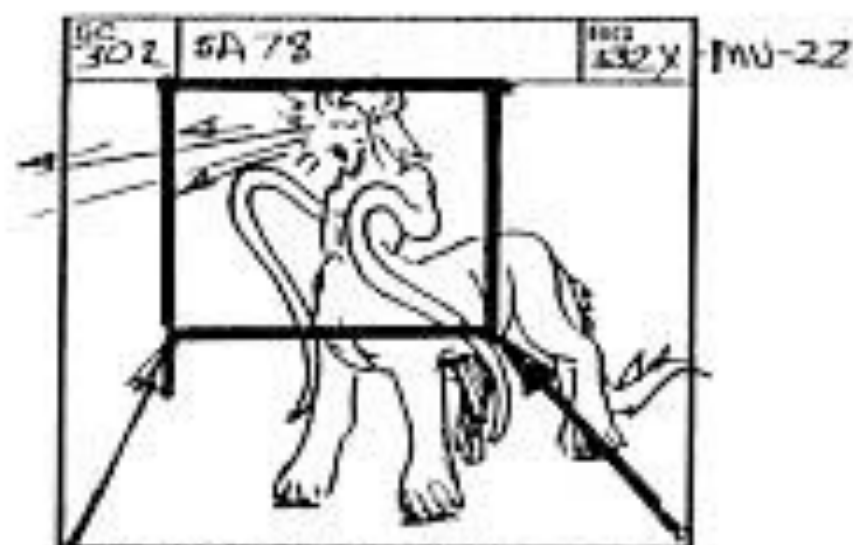

INDUKROM FIRES RAYS

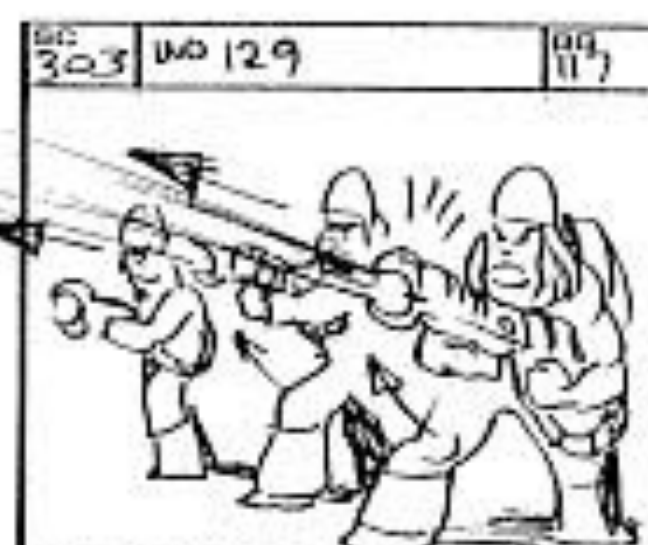

THE GUARDS FIRE RAYS FROM WEAPONS

ANIMATION  
MUTIP



STRALOS BRACES AS RAYS STRIKE ROCK



DELORA LOOKING UP AT OS STRALOS AS ORKO SEES SOMETHING AT OS (D)

DELORA  
We've got to help Stralos!

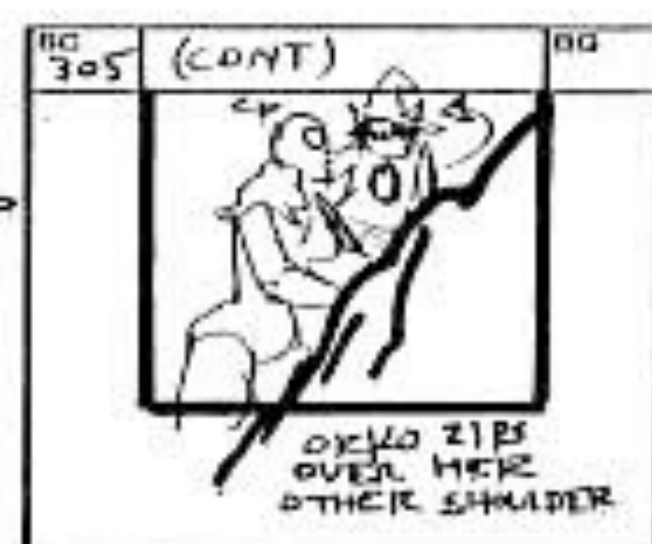

ORKO ZIPS OVER HERE OTHER SHOULDER

ORKO  
I think I know how!

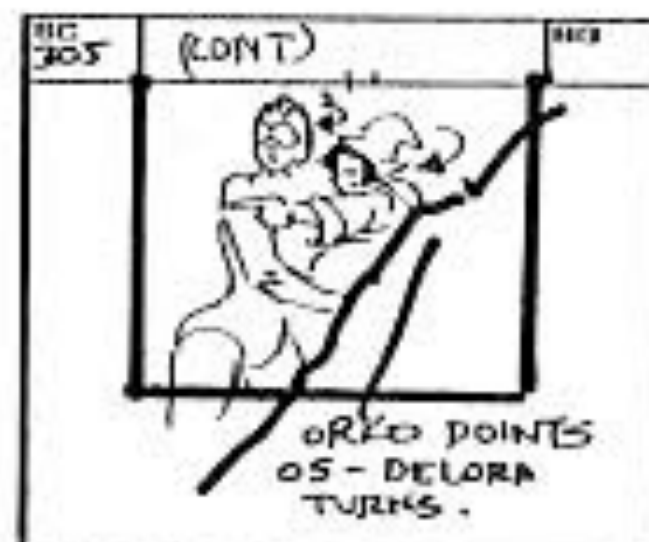

ORKO POINTS OS - DELORA TURNS.

ORKO (CONT) Look!

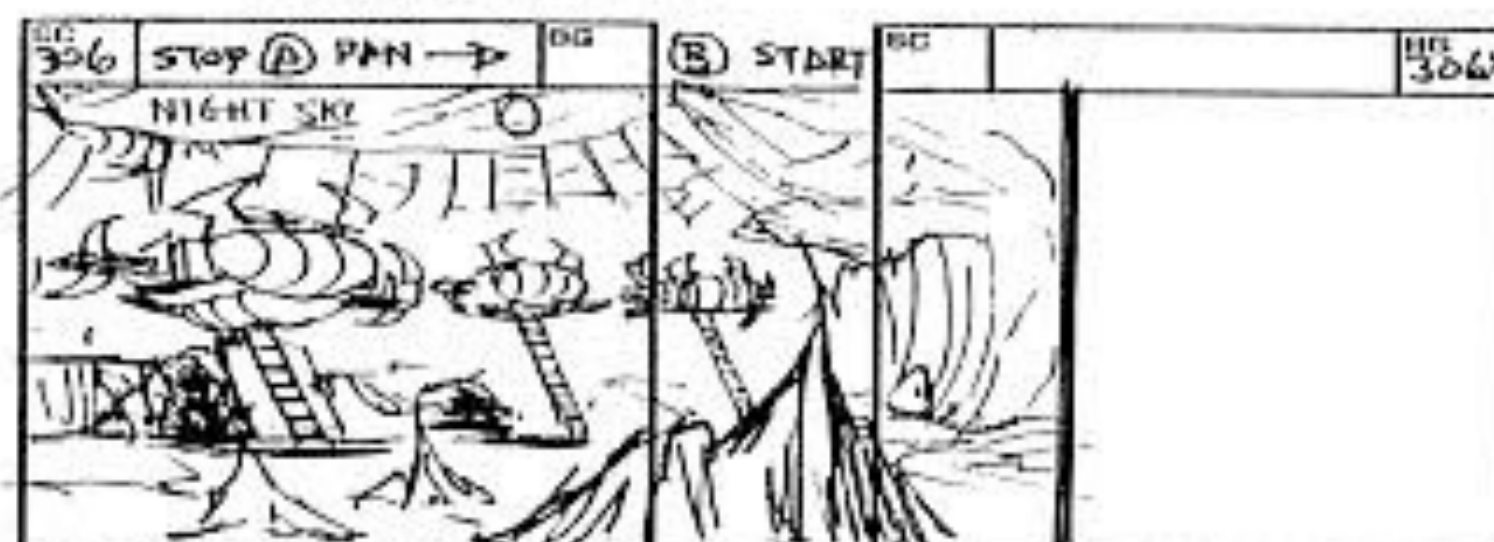

EXT - LAKE HANGER AREA OF TOROS SHIPS. THE CRAFTS HOVER IN "PARKED" POSITIONS. LADDER EXTEND FROM BOTTOM HATCHES.

SC CONT

57

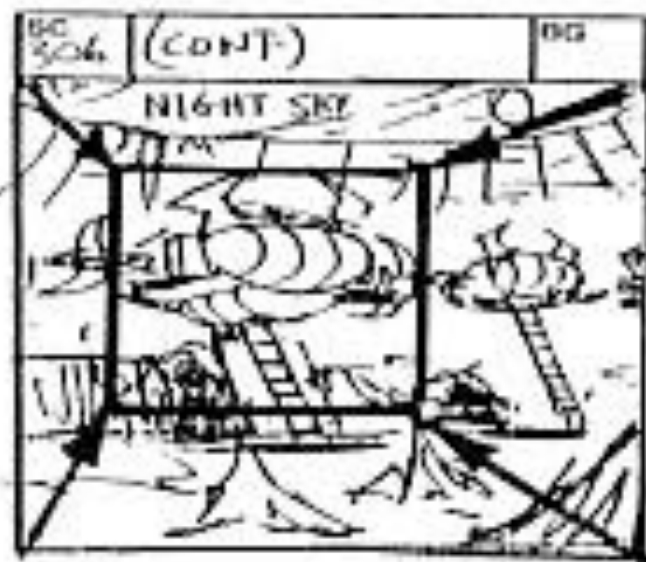

TRIL IN ON LAST SHIP.



311  
312  
321

01-10  
 PLANTING  
 1



©  
TORG  
RAYS  
IN

STRATOS HOVERS AS HE BATTLES DS TARGETS -



UL 269  
PL

TORGS FIRE WEAPONS



Ⓟ POS  
UL 268  
RAYS  
INTO  
SC

STRATOS DUCKS DOWN AS RAYS STRIKE ROCK



ORKO (OS)  
(amplified)  
Stratos!

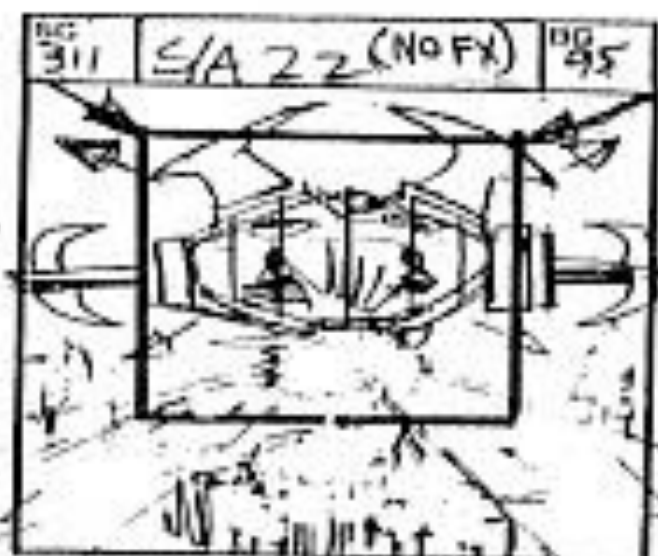

UL 95  
NICK

SHIP XEROXES TOWARD CAPT. (amplified) Get clear!



TORGS FIRE WEAPONS.

58



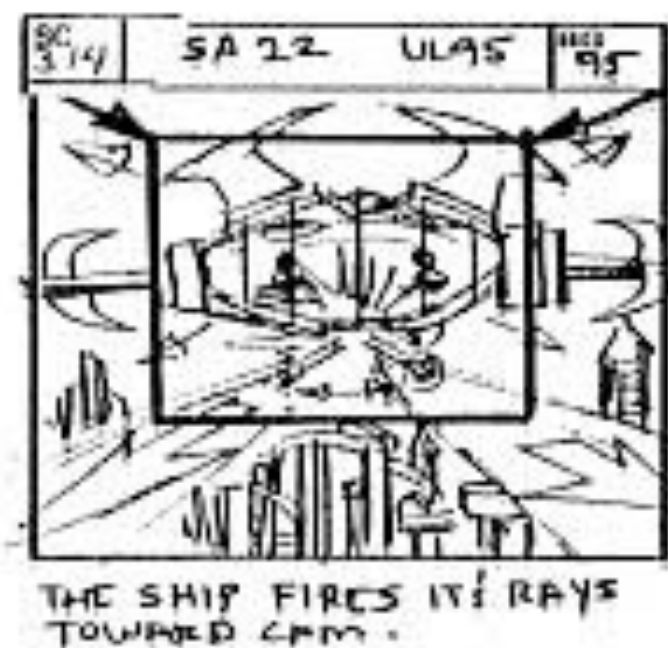
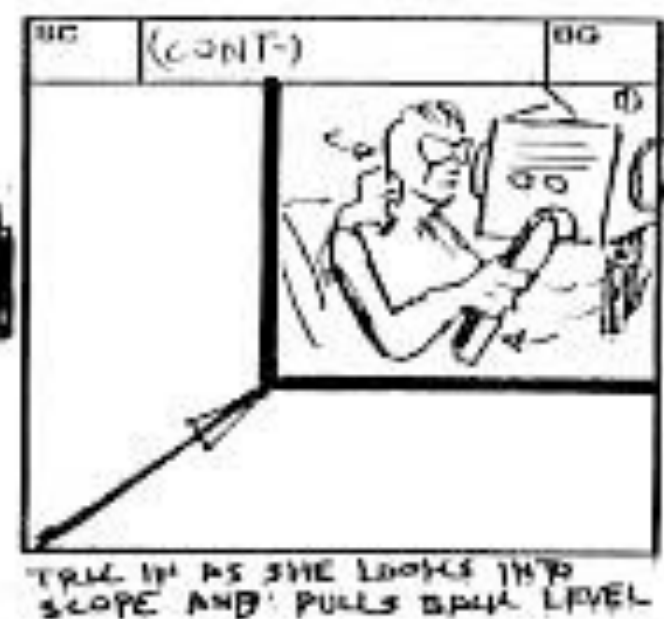
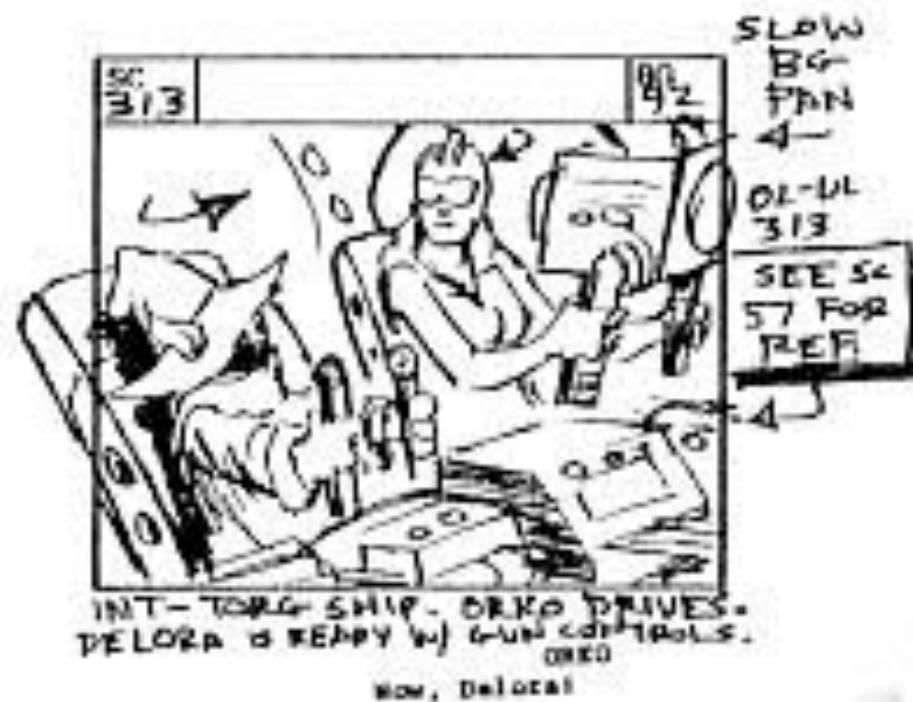

FLUORINATION STUDIOS  
M-V-L

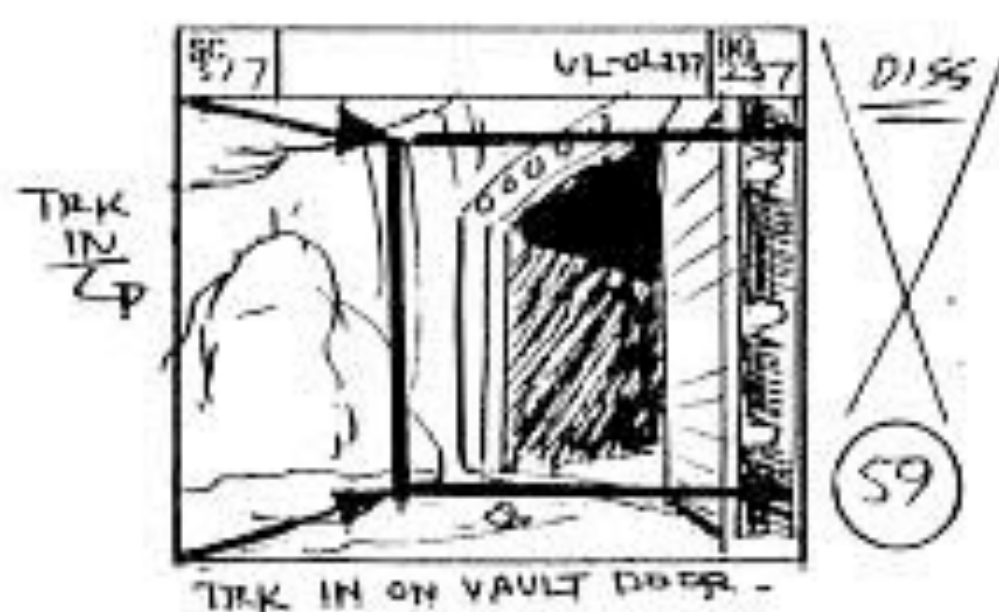
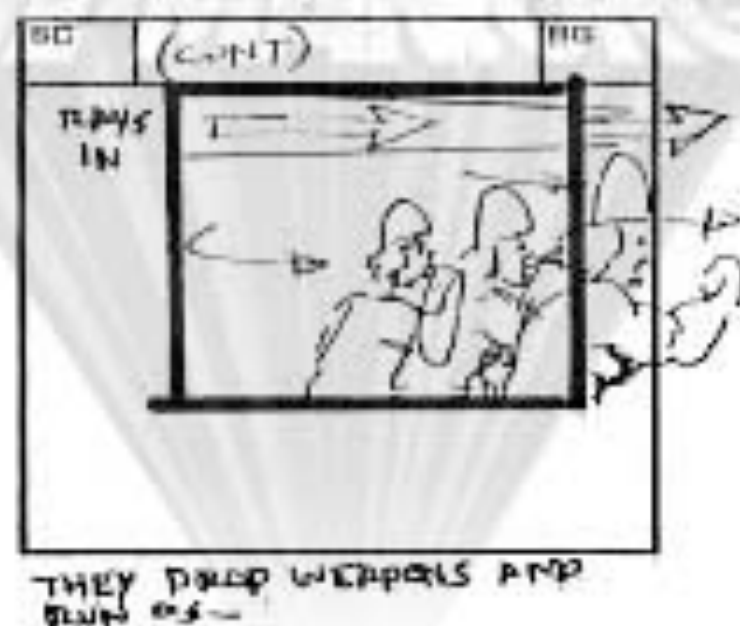
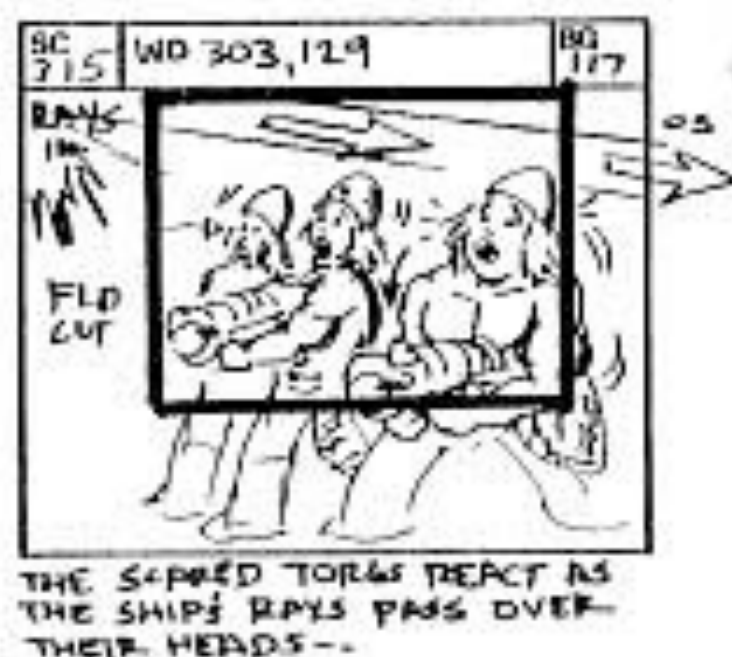



GLOWING STAFF OF AVEN LEANS ON BOX

INT-Vault-TEELA FINISHES TYING UP VON AS HE STRUGGLES W/ ROPES.

STRATOS (Vo)  
Teela! Are you all right?



TEELA BENDS TO AS STRATOS.

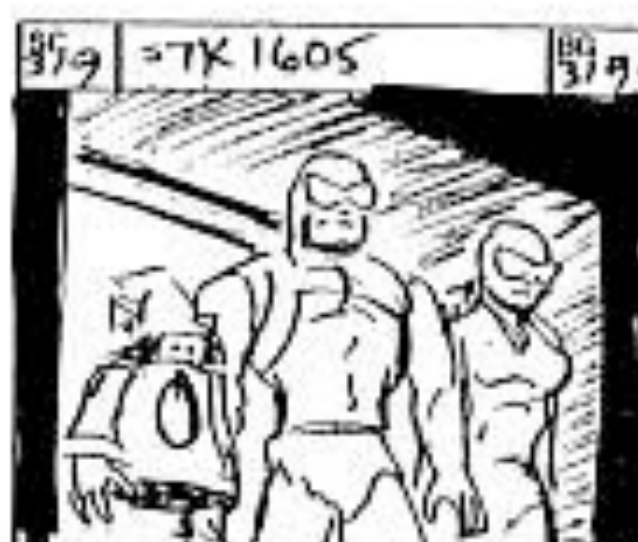

VAULT DOORWAY

ON DRAW STRATOS, AND DELORA IN VAULT DOORWAY. TEELA  
Final but there's no time to lose!

MD-16

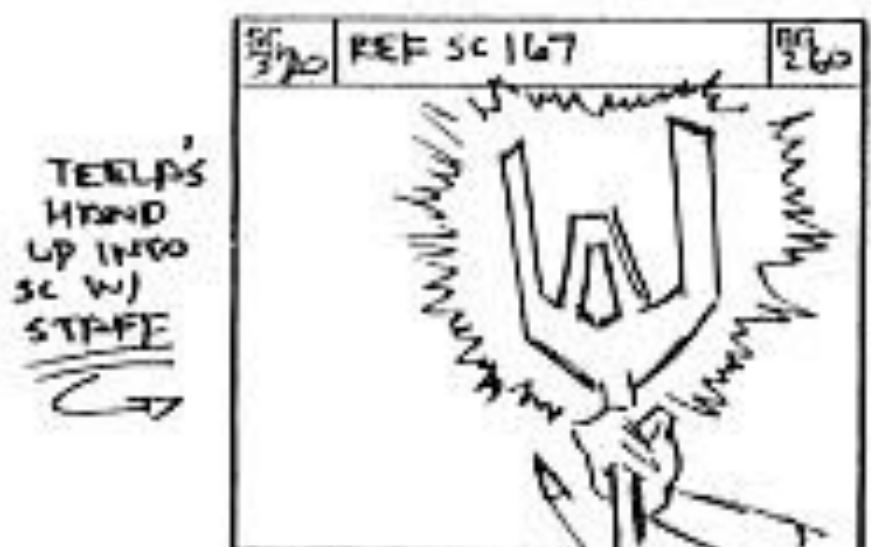

TEELA'S HAND UP INTO SC W/ STAFF

TEELA (con't) (Vo)  
Get this staff to be hot -- before it's too late!

FADE IN AND OUT SECOND COLOR  
FX OFF

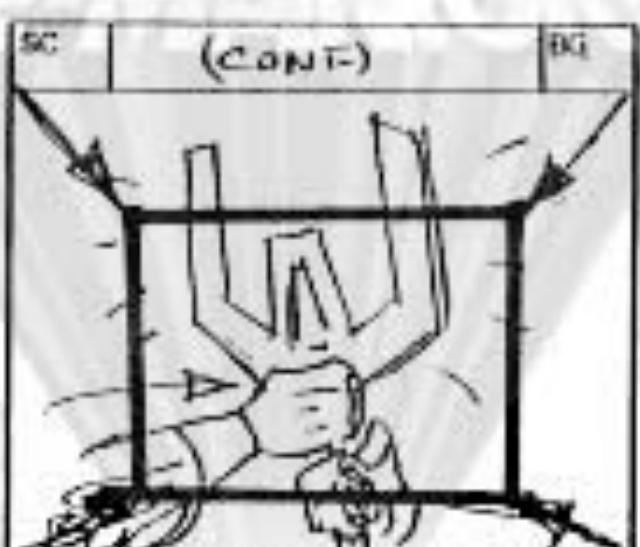

TRK IN AS STRATOS'S HAND GRABS STAFF--

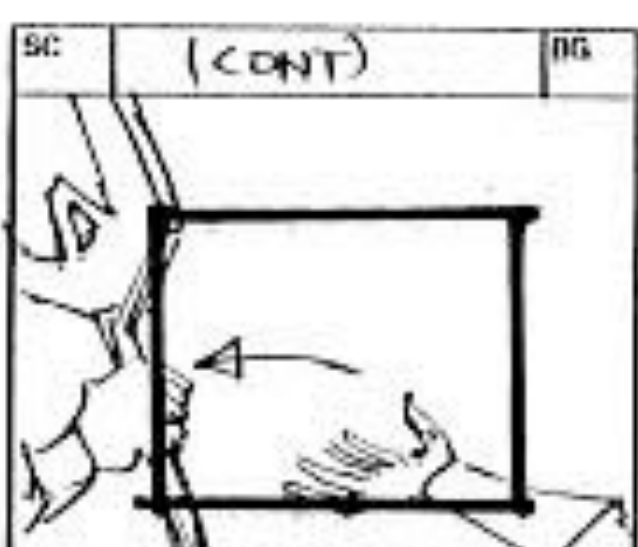

PND STRATOS TAKES IT AS.



SHADOW FX S/P SC 217  
STR LIGHTNING FX 2



SKEL CONTINUES TO FIRE RAY OF FROM STAFF AS LIGHTNING FLASHES--

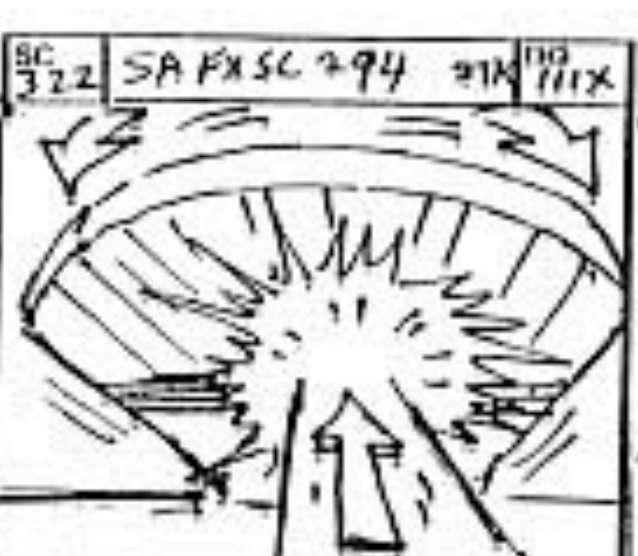

AS RAYS CONTINUE TO CYCLE. -- JB LOWERS MORE UNTIL IT STOPS HALFWAY--

STR J.B. IIX  
CONT

60



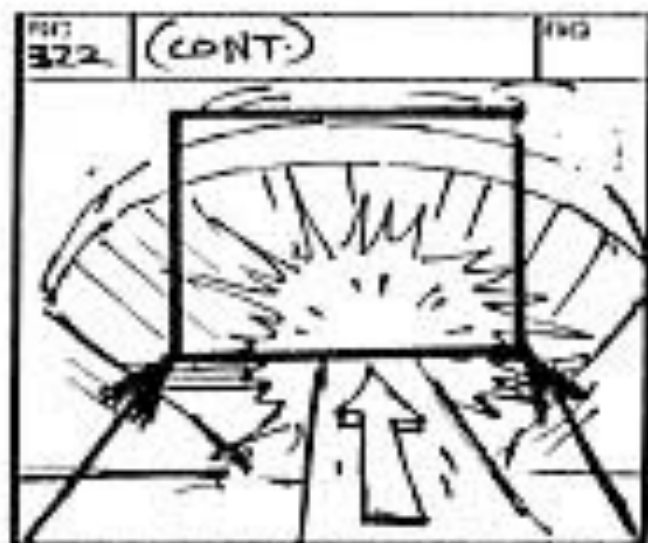

TRK IN ON JB AND RAYS



LONG ON! SORCESS PS CME FIRES MAGIC ENERGY TO CLOSE JB. SHE AND SKELETON ARE HAVING A TUG OF WAR!



CLOSER ON SORCESS FIRING BOLTS - SORCESS (straining) I must keep the Javbridge closed!

MU-9

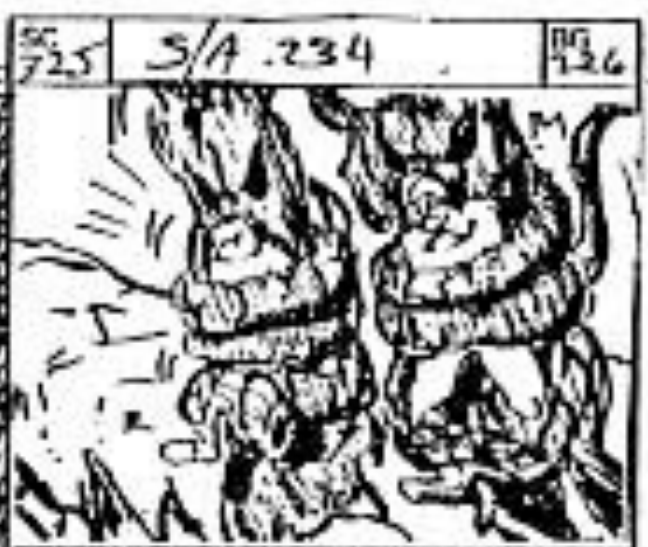

MEANWHILE, RAMMAT AND MANTA ARE STILL TRAPPED BY TREES.



MOLOKROM FIRES EYE BEAMS. (CONT.)



MOLOKROM'S ARMS BOMBARD HEMMIS SWORD. (straining) BE HAH Can't keep this up much longer!

DROP DIAL SCRIPT 523362  
 IF YOU CAN'T GET OUT OF SOMETHING...



BOYS CONTINUE TO SHOOT FROM MOLOKROM'S EYES... STRATUS (cont.)



HE STOPS BEAMS - TURNS AND LOOKS UP AND DOES A BIG TAKE.



STANDS INSIDE JC, THROWS STAFF BY PYLON OF - STRATUS (cont.)

61

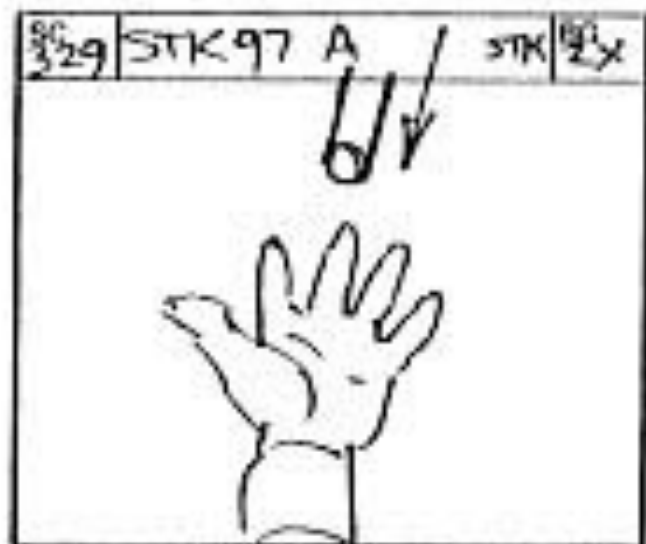

CLOSE ON HIS HAND AS HE CATCHES THE STAFF.



MOLKROM DOES A TAKE. HE KNOWS HE IS IN FOR IT NOW UNLESS HE MAKES A MOVE.

MU-16



HIM SPIES STAFF. HE HAH Molkrom, by the Staff of Avion, I command you--



MOLKROM FIRES AWAY!! MULKROM (bellow)

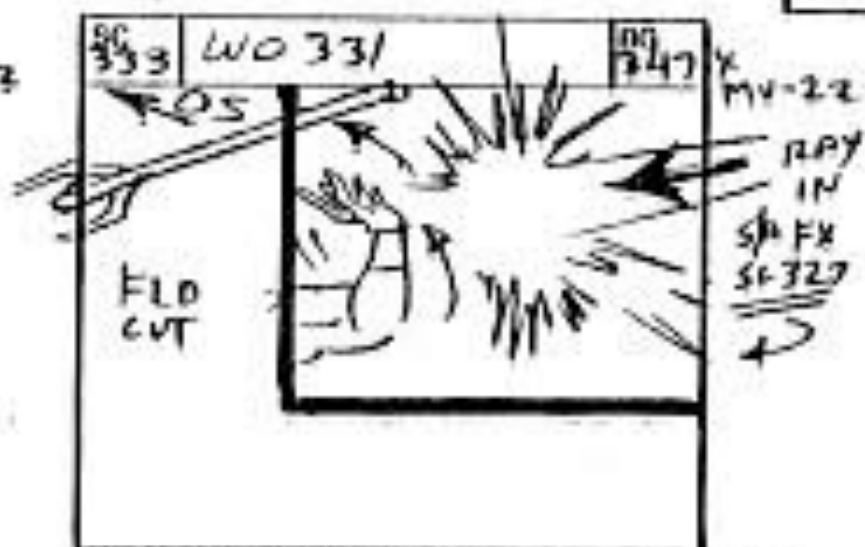

MOLKROM'S RAY ENDS UP AND STRIKE HIM'S HEAD, CAUSING THE STAFF TO FLY AS -



HAN HAH (G) HA HAH!

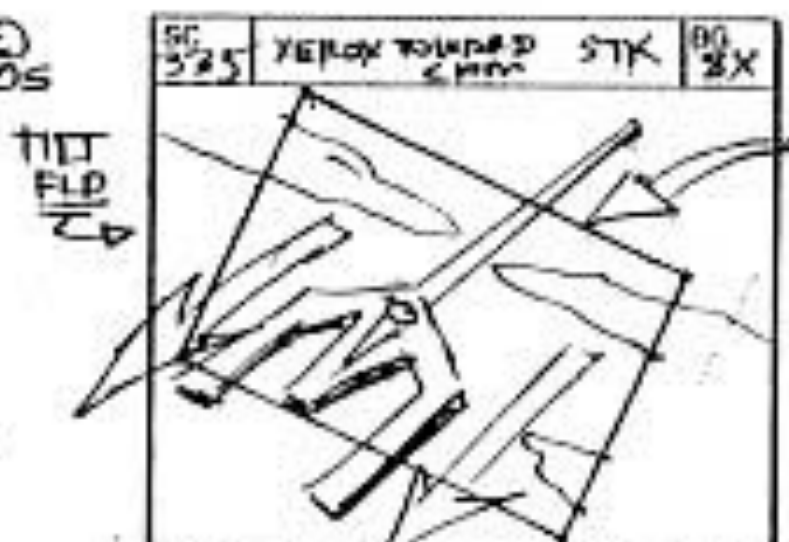

STAFF FALLS THRU SC PAST CPM IN PERSPECTIVE.

TREES SEP FROM



LONGER ON RPTMAN AND HAH TRAPPED BY TREES. THEY REM AS STAFF STABS INTO BONE SURFACE IN F.G.

(G)





ZIP TRK IN AS IT GLOWS LIKE MAD!

FADE ON GLOW FX



MAD TAKES !!

HAN AT BANG  
The staff! It's going to explode!



HERMAN PLACES SWORD BACK IN HOLSTER

NOLBRIK (OS)  
(CONT)

ANIMATION  
MU-110



MOLKROM CHARGES INTO SC ON PAN -

PAN

INTD SC

CAM SHAKE



HEROES REACT AS WE HEAR...

SFX: OS **CRASH!!!**



HERMAN LIFTS MOLKROM - ANTIK.

NOLBRIK (VO)  
(angry roar)

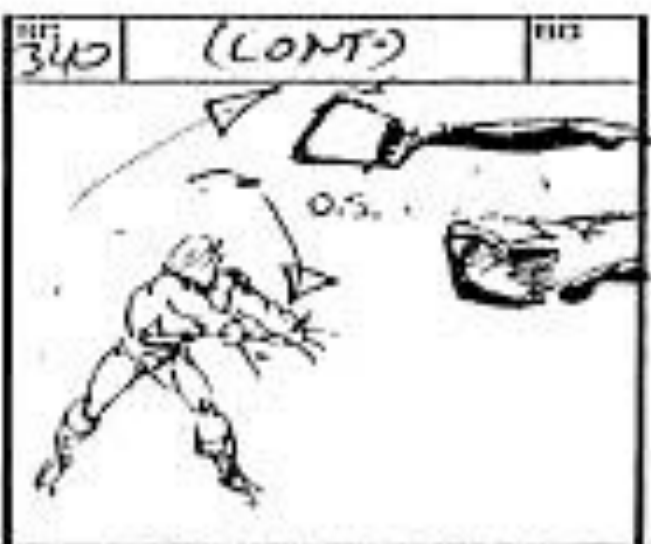

HAN THROWS SPDBUY OS -



MOLKROM SALES THRU FF -

CAM SHAKE

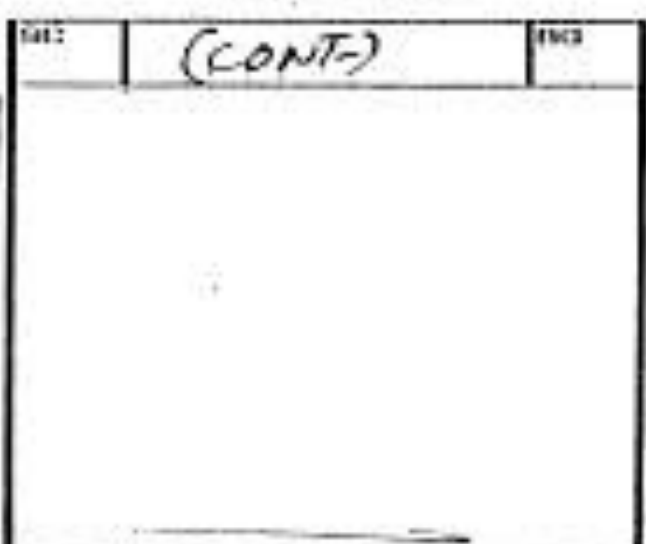

HOLD ON BG

SFX: OS **CRASH!!!**

63



HE MAN THRU SC



TRK IN ON GLOWING STAFF AS --

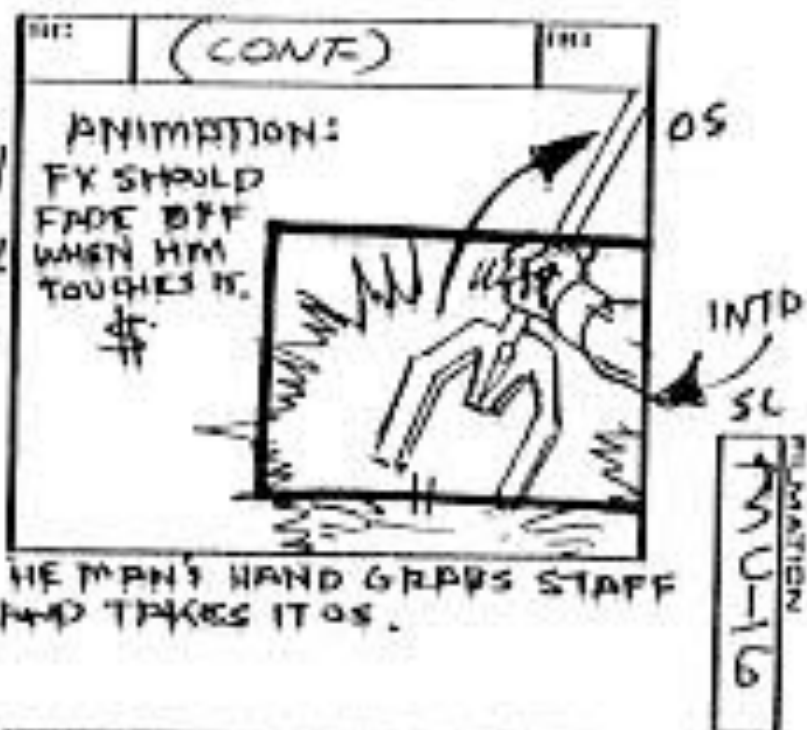

HE MAN'S HAND GRABS STAFF AND TAKES IT OS.



HM ANTLES --



THROWS THE STAFF UP AND OS -

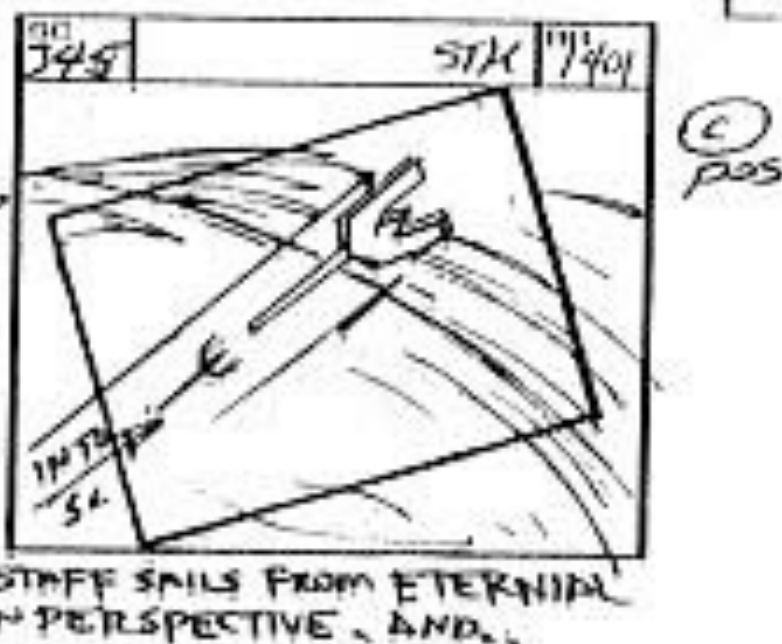

STAFF SALES FROM ETERNAL IN PERSPECTIVE AND.

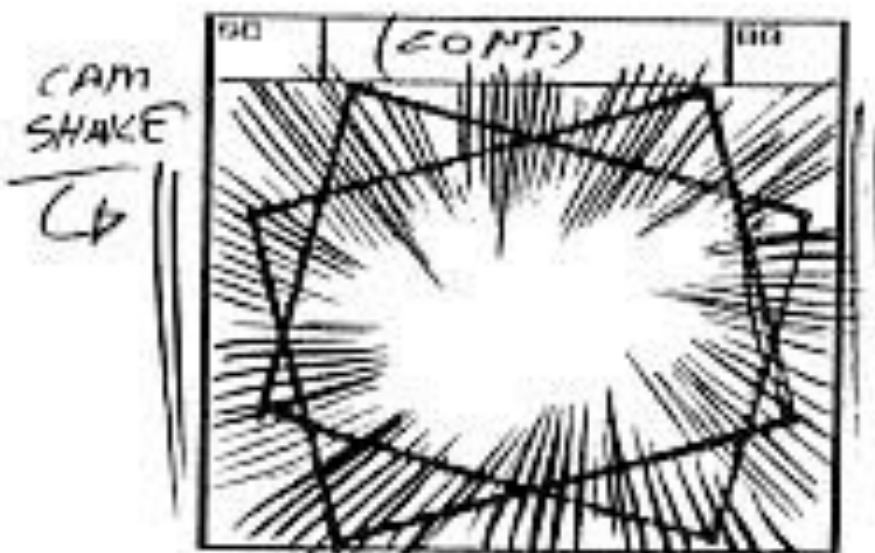

CAM SHAKE

EXPLODES!!!



MOLKROM COVERS HIS FACE TO SHIELD EYES FROM BLINDING FX - RODS W/ ANGER

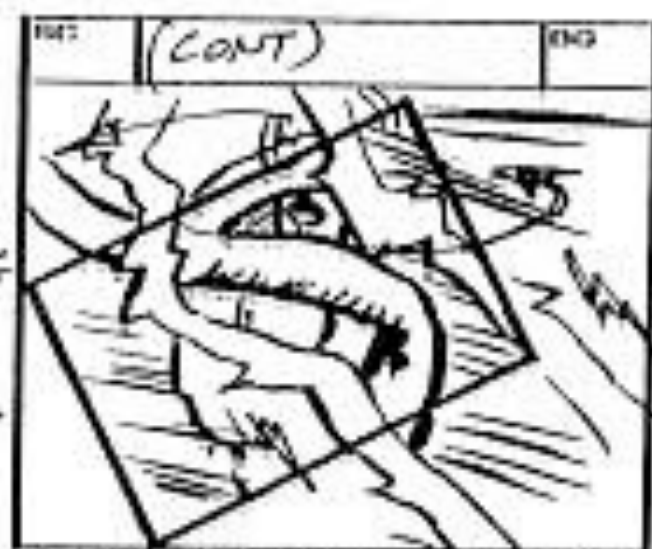

HE SWINGS ARMS WILDLY AS HE REALIZES WHAT IS ABOUT TO HAPPEN...

64





HE HAH  
Back to your prison, Molkrom!



MOLKROM RIDES AS FX ENAME  
HIS WHOLE BODY  
MOLKROM  
(below)



THE PIECES OF HIS CRYSTAL  
PRISON FLY BACK INTO SC

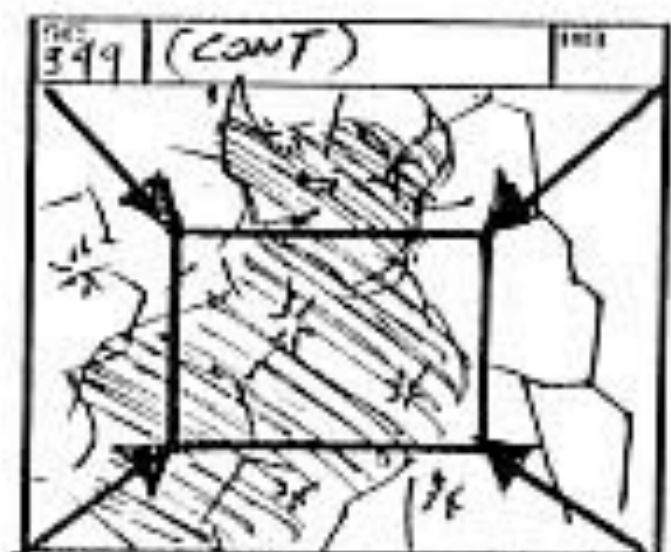

THEY IN AS ALL PIECES RE-SHAPPE  
BACK INTO THE CRYSTAL CAGE,  
ENCAPSING MOLKROM.



LONGER ON MOLKROM IN  
HIS CRYSTAL PRISON  
MAN AT ARMS 1001  
Molkrom is back in the crystal!



THE TREES DISSOLVE OFF,  
AND RAMMOR AND M/A/A  
ARE FREE.

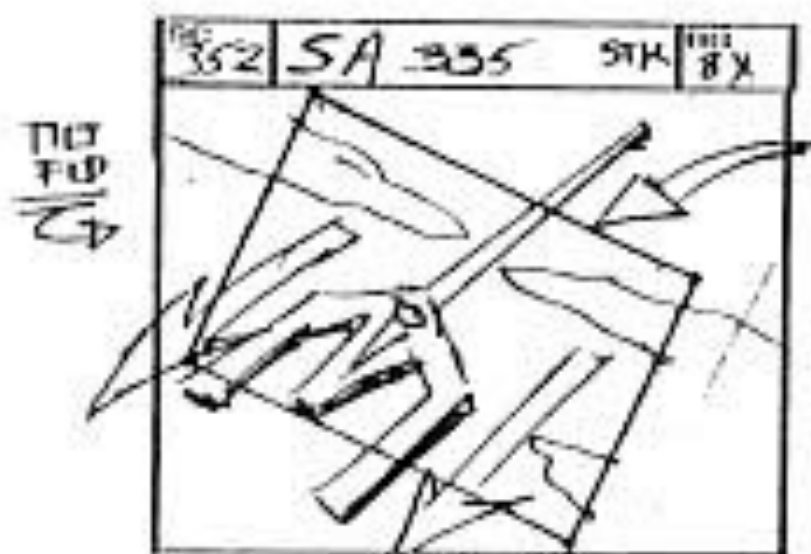

THE STAFF FALLS THRU SC-



ON HEROES AS STAFF STABS INTO  
GROUND  
MAN HAH (08)  
And the staff is back to normal!



MAN AT ARMS  
(Dowl) That was a close one!

NOTE:  
GLOW  
FX

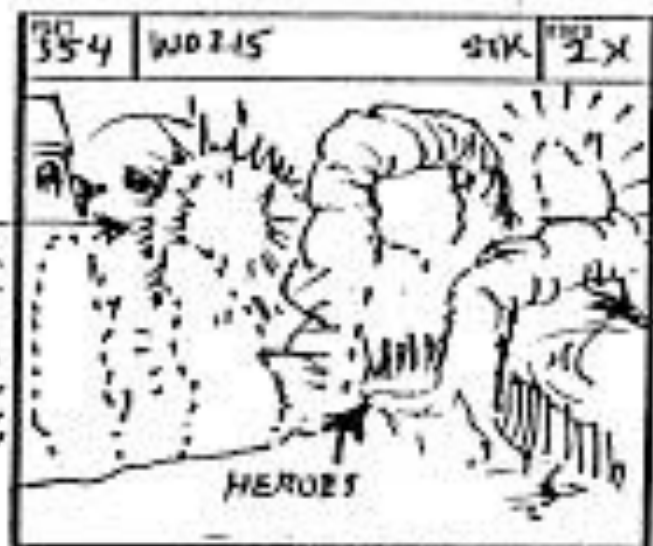

LONGER AS HEROES WATCH IN SILENCE  
THE EVIL TREES DISSOLVE. THERE IS A  
CONTINUOUS GLOW AROUND THE  
J.B. OF GRAYSKULL. STRATOR (VO)  
(good work, Be Man)

UL215X  
UL-02  
215X



HM REACTS  
SORCERESS (VO)  
(weakly; reverbed)  
Be Man - help!

MU-9



SORCERESS (VO, cont'd)  
(restraining; reverbed)  
I'm weakening!

J.B. STARTS  
TO LOWER!  
OS

FILMATION  
MU-16

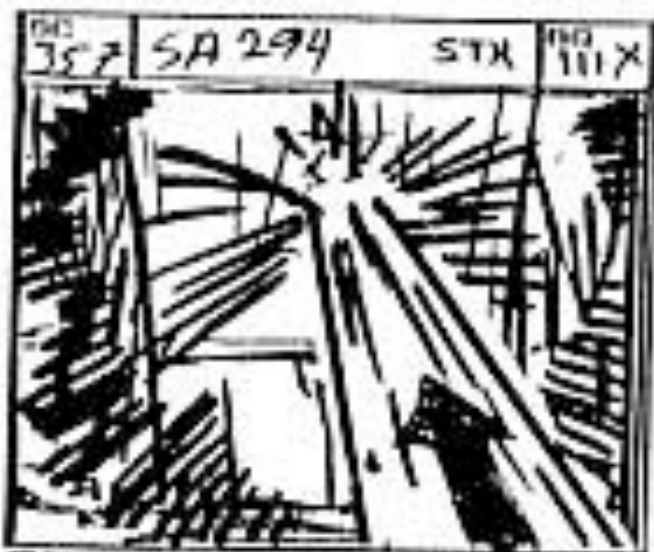

RAYS OF SKELETON CONTINUE TO  
STRIKE J.B. UNTIL... SORCERESS (VO, cont'd)  
(restraining; reverbed)  
Skeleton is lowering the Jawbridge!

STK  
J.R.  
111X

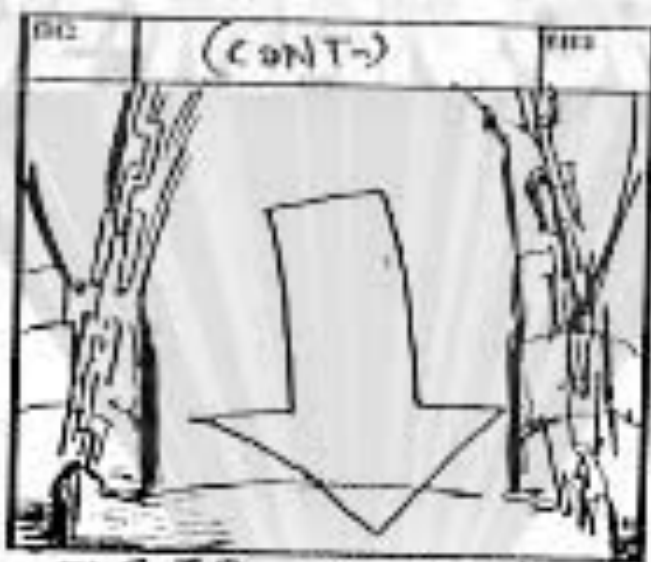

THE J.B. OPENS!!

FADE  
FX  
OFF  
4



TRK IN AS SKEL LOWERS HIS  
RAM STAFF. SKELETON  
At least! Grayskull is mine!

MU-9  
UL-02  
145X  
MU-9

FLO  
CUT  
LD



SKELETON WALKS OS -

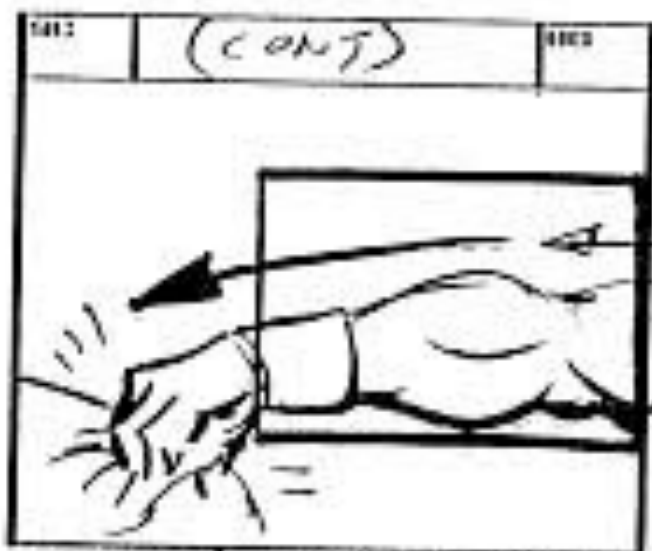

HE MANS ARM REACHES  
THRU SC -



HE YANKS SKEL THRU SC -

as

66



STRINGS  
HOLDS  
STAFF  
OF  
AVION



HE MAN HOLDS SKEL IN BEER-HUG-  
PS OTHER HEROES LOOK ON.  
EE HAH  
Gong scowls, Skeletor?

360 SA 361 MU-22 145X  
MU-9  
UL-OL  
145X  
MU-9  
HOOK  
UP  
SKEL

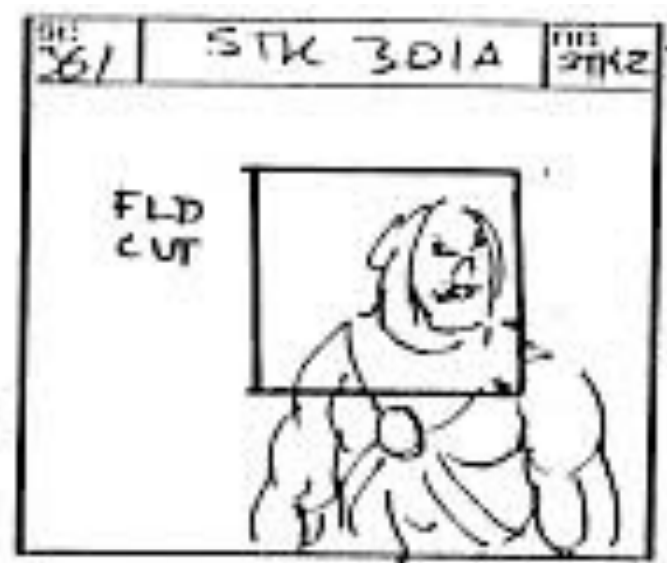

SKELTON  
Vary well, Be Man! Another time!

HOOK  
UP  
SKEL



HEROES REACT AS SKELETOR  
DISSOLVES AND DISAPPEARS.

362 WO 360 145X  
-MU-9  
UL-OL  
145X  
MU-9

ILLUMINATION  
MU-9

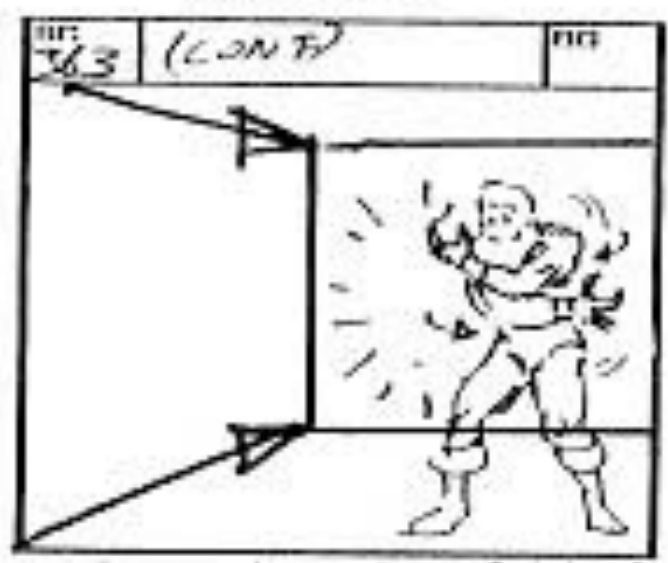

ZIP TRUCK ON HE MAN LOOKING



HE MAN  
(defiant)  
Any time you like!



STRINGS  
HOLDS  
STAFF



EXT-AVION - HE MAN ADDRESSES  
CROWD  
EE HAH  
How to begin the festival!

NO  
DIAL



TEELA  
Let's hope there aren't any  
wire interruptions!

SC  
CONT  
17



THEY LOOK @ @

ORKO 1001  
He Next Help!

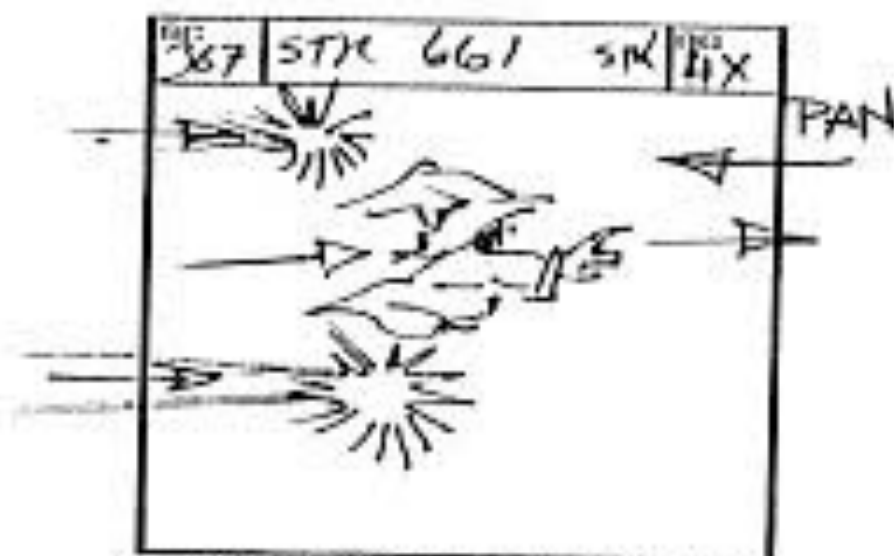

ORKO GRIPS THRU SL 125  
FLASHES OF HARMLESS  
LIGHT BURSTS INTO SC -

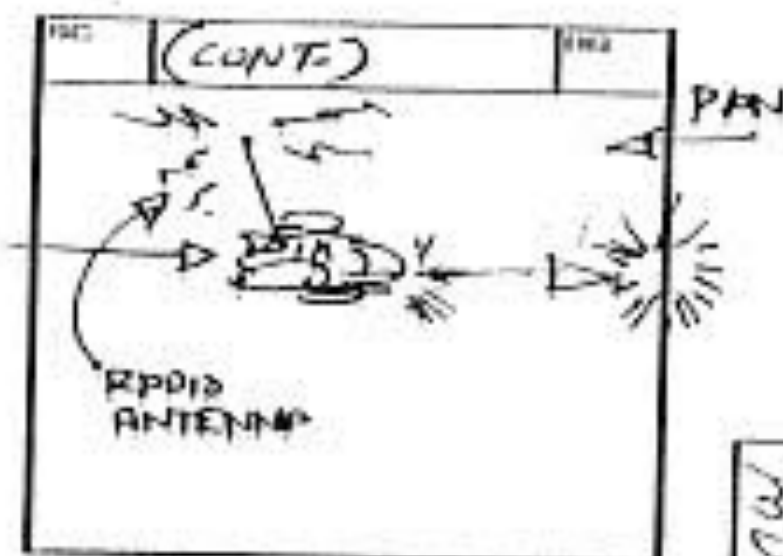

REVEAL HIS "ATTACKER"  
IS A TOY SPACE SHIP LIKE  
THE TORGs.

REMARKS  
MU-16



CUT TO MEAN LITTLE BIRDCHILD  
AS HE WORKS CONTROL BOY

ORKO (CODE 'C')  
He-elp!



HM LAUGHS.

SFX: FIREWORKS  
SOUNDS (laughter)



LONGER ON AVION CITY TOWERS AS  
BOLT FIRES UP INTO SKY AND BURSTS  
INTO FIREWORKS FX - AVION POPPAGE  
(cheers)

DX  
FX  
TRK  
OUT

FADE  
OUT

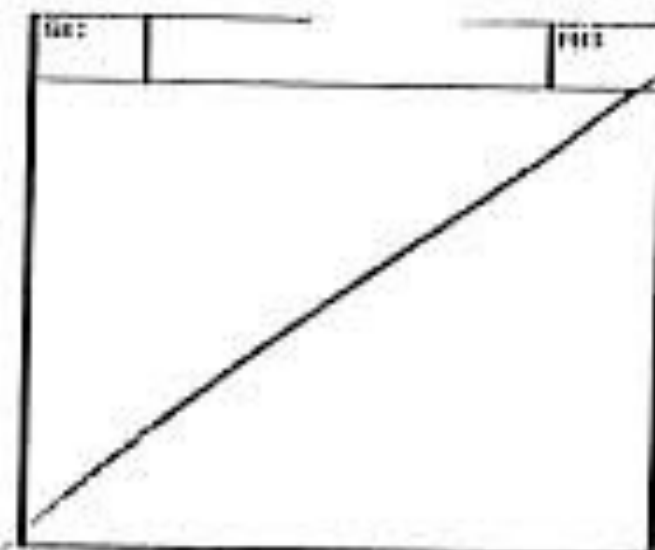
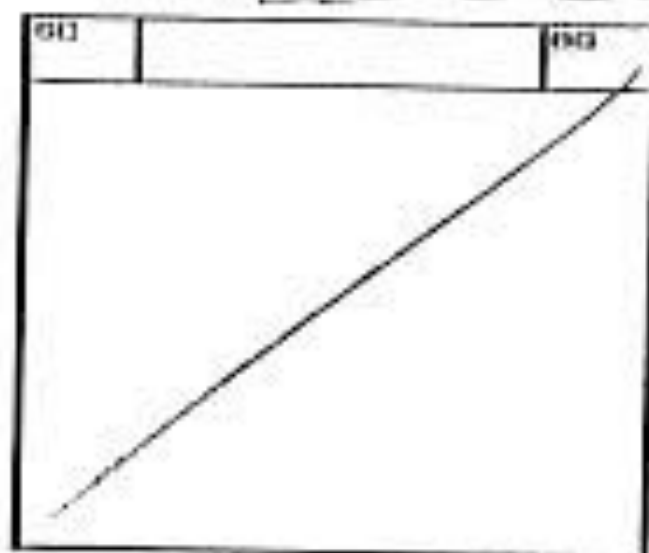
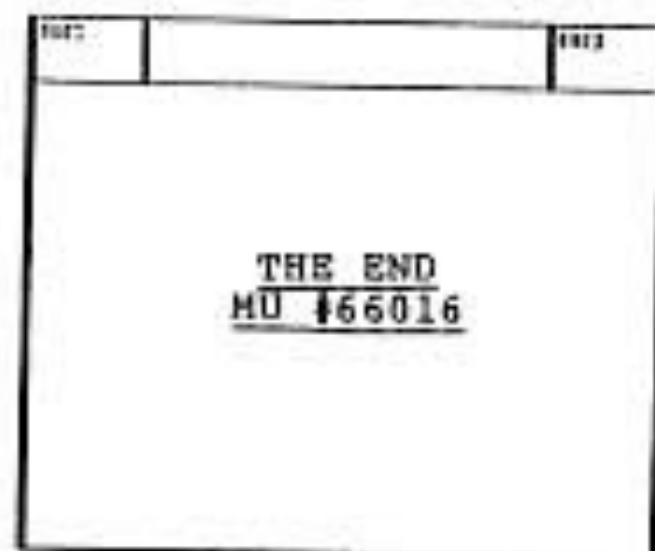

(68)